

 **Kistenberg**

**x black x black**

546 x 380 x 307 MM

**X Block PRO**  
tool box

**INTERLOCKING SYSTEM**

- ✓ FLEXIBLE CASKET
- ✓ PROTECTIVE FOAM
- ✓ PERFECT ALIGNMENT
- ✓ DUST AND WATER

✓ A PRECISE SLOT WITH A MEASURE

✓ LOCK FOR A LOCK

KXB604030

 **Kistenberg**

You craft, we store.











## Index

<b>X Block PRO</b>	p. 8 - 9
<b>X Block LOG</b>	p. 10 - 11
<b>X Block ALU LOG</b>	p. 12 - 13
<b>X Block TECH</b>	p. 14 - 15
<b>X Block Set</b>	p. 16 - 17
<b>X Block BRIDGE</b>	p. 18
<b>X Block Wagon PRO/TECH</b>	p. 24
<b>X Block PRO</b> basket	p. 25
<b>S Block PRO</b>	p. 28
<b>S Block ALU LOG</b>	p. 29
<b>Modular Solution</b>	p. 32 - 35
<b>MSX</b>	p. 36 - 37
<b>MSX Set</b>	p. 38 - 39
<b>Platform</b>	p. 42 - 43
<b>Heavy</b>	p. 44 - 51
<b>Titan Plus</b> tool box	p. 52 - 53
<b>Optima</b> tool box	p. 54 - 59
<b>Evo</b> tool box	p. 60 - 65
<b>Aptop Plus</b> tool box	p. 66
<b>Caliber</b> tool box	p. 67
<b>Smart / IML</b> tool box	p. 68 - 69
<b>Cargo Plus</b> tool tray	p. 70
<b>Cargo</b> tool tray	p. 71
<b>Titan</b> organiser	p. 72 - 75
<b>Tager Carbo Plus</b> organiser	p. 76 - 81
<b>Tager</b> organiser	p. 83 - 87
<b>Tager Case</b>	p. 88

<b>Multicase Cargo</b> case	p. 89
<b>Nor / Nor Duo</b> organiser	p. 90 - 91
<b>Nors / Nors Duo</b> organiser	p. 92 - 93
<b>Norb / Norb Duo</b> organiser	p. 94 - 95
<b>MSX Box</b>	p. 97
<b>Nort &amp; Knox</b> organiser	p. 98
<b>Nun</b> organiser	p. 99
<b>Battery Box</b>	p. 100 - 101
<b>Truck Max</b> storage bin	p. 102 - 103
<b>Click Box</b> storage bin	p. 105
<b>Exe</b> storage bin	p. 106 - 107
<b>Truck</b> storage bin	p. 108 - 109
<b>Bineer Short</b> storage bin	p. 110 - 111
<b>Bineer Long</b> storage bin	p. 112 - 113
<b>Titan / X Block / Unite</b> box set	p. 114 - 115
<b>Settruck</b> set of storage bins	p. 116
<b>Multiholder</b> hanger	p. 117
<b>Orderline</b> tool board set	p. 118 - 119
<b>Bineer Board / Accessories</b>	p. 120 - 121
<b>Titan Stand</b>	p. 123
<b>Titan Ladder</b>	p. 125
<b>Bucket</b>	p. 126
<b>Container</b>	p. 127

## Designations

Designations in the tables [pictographs]

	symbol
	length - mm
	width - mm
	height - mm
	maximum load
	maximum weight
	polybag quantity
	carton quantity
	number of pieces on a Europalette
	pallet height - mm
	information



# You craft, we store.

Each KISTENBERG product is approached individually. Each element is designed with attention to the tiniest details. Apart from their appearance, we focus on their practical purpose. Each product has its own color profile to maintain ultimate color coordination. All elements are assembled manually, in full compliance with the requirements specified in the technical documentation. Thus, we can be sure that we deliver to you the product of the highest quality which you will be able to enjoy for many long years.



Polycarbonate organizer flaps provide higher impact resistance and improve the appearance of all our tool boxes.

Fastenings made from resilient components such as steel, aluminum, ABS and ABS with elastomer guarantee durability and the comfort of use.

Dust and water resistance as well as protection from weather conditions.

Multiple sales variants and sizes available. We offer a selection of various types of covers, fastening, fitting and accessories for storing small elements.

The wide assortment of KISTENBERG products and their multifunctionality enable organizing the space of your workshop, garage or construction site. The possibility of combining, stacking, mounting and others help better organize your workspace, and make your work a more enjoyable experience.

The value of a brand depends largely on the perception of the product's quality, its durability, how long its life is, and how consumers rank it against the competition.

To ensure the highest quality and meet users' expectations, all components of our products are manufactured from materials of the highest quality.

Before any product is marketed, it undergoes rigorous testing toward its utility, defectiveness, comfort of use, visual appeal of the finished product and other essential features that contribute to its character.

Thus, we can guarantee that we offer a product of the highest quality and resilience which will satisfy the expectations of even the most demanding users.



 **Kistenberg**

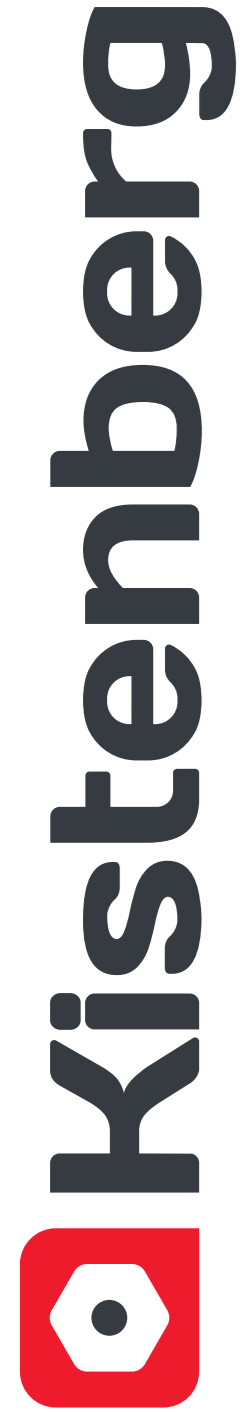

## X Block modular system



The **X Block modular system** has been especially designed for professionals working in harsh conditions on a daily basis. The tightly designed boxes with a solid gasket available in PRO, LOG line are IP65 rated dust-tight and waterproof workshop containers for storing and transporting heavy tools.

The set consists of three units. The first of them is a mobile module in built-in version. It is equipped with elastomer-covered treaded wheels and an aluminium telescopic handle for improved balance and better driving comfort. The module is provided with two side organisers and two carriers making it easier to keep the hand tools organised within the box. The second unit is X-Block organiser. It is fitted with two handles for easy transport. The tool organiser is built into the lid. The detachable cups and dividers inside the unit make it possible to organise the space for small items.

The last component of this set is a basket with two detachable organisers that divide its large space into areas for storing smaller tools.



# X Block PRO modular system



plain lid



	X BLOCK PRO case	X BLOCK PRO tool box	X BLOCK PRO tool box
	KXB604020	KXB604030	KXB604040
colour	S411	S411	S411
mm	546 x 380 x 194	546 x 380 x 307	546 x 380 x 407
kg	~ 50	~ 50	~ 50
pcs	-	-	-
pcs	36	24	16
mm	~ 1760	~ 1910	~ 1720
	interlocking system, boxes, plain lid, metal hinges, 2 x handles for easy carrying	interlocking system, 2 x trays, 2 x separators, plain lid, metal hinges	interlocking system, 2 x trays, 2 x separators, plain lid, metal hinges



- X BLOCK PRO:**
- Very durable body with reinforced structure
  - Boxes and internal separators for organizing the interior space
  - Solid gasket ensures that the product is dustproof and water resistant
  - Pressure resistance up to 120 kg



	X BLOCK PRO tool trolley	X BLOCK PRO tool trolley	X BLOCK PRO tool trolley
	KXB604045	KXB604050	KXB604050D
colour	S411	S411	S411
mm	546 x 380 x 400	546 x 380 x 510	546 x 380 x 510
kg	~ 50	~ 50	~ 50
pcs	-	-	-
pcs	16	12	12
mm	~ 1750	~ 1830	~ 1830
	interlocking system, 2 x tray, 2 x tool holder, 2 x separators, plain lid, metal hinges	interlocking system, 2 x tray, 2 x tool holder, 2 x separators, plain lid, metal hinges	interlocking system, drawer, 2 x tray, 2 x tool holder, plain lid, metal hinges



# X Block LOG modular system

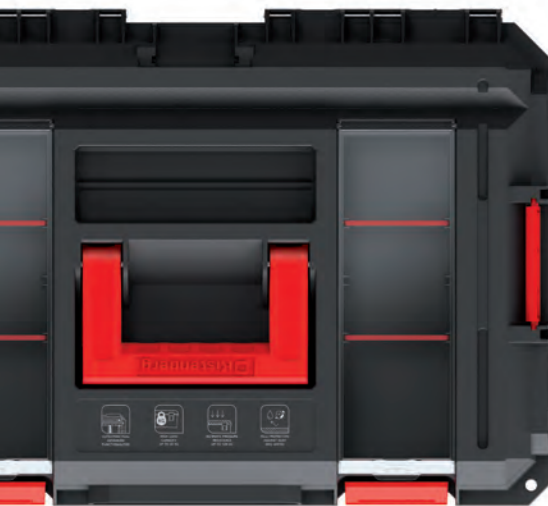

organiser set in the lid

- X BLOCK LOG:**
- Very durable body with reinforced structure
  - Boxes and internal separators for arranging the interior space
  - Solid gasket ensures that the product is dust proof and water resistant
  - Transparent organizers with a polycarbonate covers
  - Separators in the organizer
  - Tool organizer in the cover
  - Pressure resistance up to 120 kg



	X BLOCK LOG case	X BLOCK LOG tool box	X BLOCK LOG tool box
	KXB604020F	KXB604030F	KXB604040F
colour	S411	S411	S411
mm	546 x 380 x 194	546 x 380 x 307	546 x 380 x 407
kg	~ 50	~ 50	~ 50
pcs	-	-	-
pcs	36	24	16
mm	~ 1760	~ 1910	~ 1720
	interlocking system, boxes, organiser set in the lid, metal hinges, 2 x handles for easy carrying, 6 x separators	interlocking system, 2 x trays, 6 x separators, organiser set in the lid, metal hinges	interlocking system, 2 x trays, 6 x separators, organiser set in the lid, metal hinges



	X BLOCK LOG tool trolley	X BLOCK LOG tool trolley	X BLOCK LOG tool trolley
	KXB604045F	KXB604050F	KXB604050FD
colour	S411	S411	S411
mm	546 x 380 x 400	546 x 380 x 510	546 x 380 x 510
kg	~ 50	~ 50	~ 50
pcs	-	-	-
pcs	16	12	12
mm	~ 1750	~ 1830	~ 1830
	interlocking system, 2 x tray, 2 x tool holder, 6 x separators, organiser set in the lid, metal hinges	interlocking system, 2 x tray, 2 x tool holder, 6 x separators, organiser set in the lid, metal hinges	interlocking system, drawer, 2 x tray, 2 x tool holder, 4 x separators, metal hinges organiser set in the lid





# X Block ALU LOG modular system

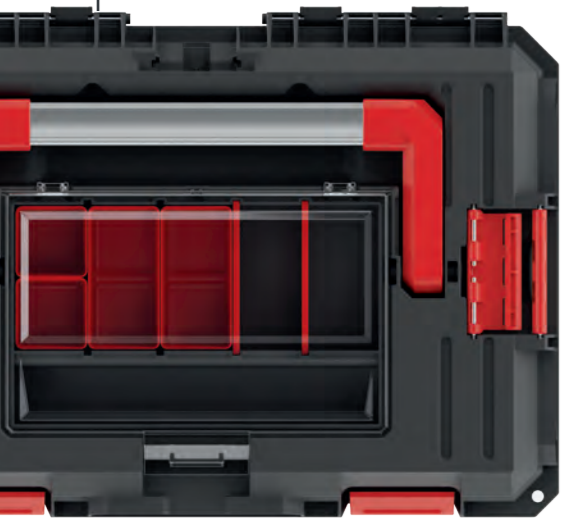

organiser set in the lid

**X BLOCK ALU LOG:**

- Organiser with separators and boxes in the lid
- Interlocking system for joining with X Block and S Block series
- Very durable body with reinforced structure
- Solid gasket ensures that the product is dust proof and water resistant
- Functional internal partitions for arranging the interior space
- Durable ABS latches
- Organiser with separators and boxes in the lid
- Aluminium handle
- Pressure resistance up to 120 kg

new



new



	X BLOCK ALU LOG tool box	X BLOCK ALU LOG tool box
	KXBA604030	KXBA604040
colour	S411	S411
mm	546 x 380 x 307	546 x 380 x 407
kg	~ 50	~ 50
pcs	-	-
pcs	24	16
mm	~ 1910	~ 1720
	interlocking system, 2 x trays, 6 x separators, 4 x boxes, organiser set in the lid, metal hinges	interlocking system, 2 x trays, 6 x separators, 4 x boxes, organiser set in the lid, metal hinges



new



new



new



	X BLOCK ALU LOG tool trolley	X BLOCK ALU LOG tool trolley	X BLOCK ALU LOG tool trolley
	KXBA604045	KXBA604050	KXBA604050D
colour	S411	S411	S411
mm	546 x 380 x 400	546 x 380 x 510	546 x 380 x 510
kg	~ 50	~ 50	~ 50
pcs	-	-	-
pcs	16	12	12
mm	~ 1750	~ 1830	~ 1830
	interlocking system, 2 x tray, 2 x tool holder, 6 x separators, organiser set in the lid, metal hinges, 4 x boxes	interlocking system, 2 x tray, 2 x tool holder, 6 x separators, organiser set in the lid, metal hinges, 4 x boxes	interlocking system, drawer, 2 x tray, 2 x tool holder, 4 x separators, metal hinges, organiser set in the lid, 4 x boxes



# X Block TECH modular system

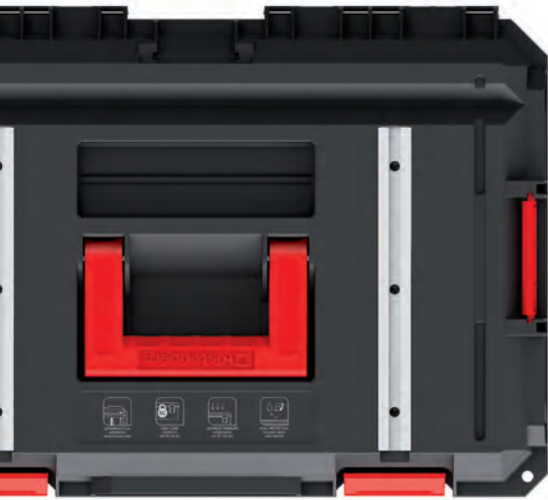

rails for G-clamps



	X BLOCK TECH case	X BLOCK TECH tool box	X BLOCK TECH tool box
	KXB604020G	KXB604030G	KXB604040G
colour	S411	S411	S411
mm	546 x 380 x 194	546 x 380 x 307	546 x 380 x 407
kg	~ 50	~ 50	~ 50
pcs	-	-	-
pcs	36	24	16
mm	~ 1760	~ 1910	~ 1720
	interlocking system, 6 x boxes, metal hinges, rails for G-clamps set in the lid, 2 x handles for easy carrying, 2 x separators	interlocking system, 2 x trays, 2 x separators, metal hinges, rails for G-clamps set in the lid,	interlocking system, 2 x trays, 2 x separators, metal hinges, rails for G-clamps set in the lid,



- X BLOCK TECH:**
- Very durable body with reinforced structure
  - Large load capacity, easy transport of even the heaviest tools
  - Solid gasket ensures that the product is dust proof and water resistant
  - Aluminum rails allowing the attachment of G-clamps, turning the box into a compact „workshop table“
  - Pressure resistance up to 120 kg



	X BLOCK TECH tool trolley	X BLOCK TECH tool trolley	X BLOCK TECH tool trolley
	KXB604045G	KXB604050G	KXB604050GD
colour	S411	S411	S411
mm	546 x 380 x 400	546 x 380 x 510	546 x 380 x 510
kg	~ 50	~ 50	~ 50
pcs	-	-	-
pcs	16	12	12
mm	~ 1750	~ 1830	~ 1830
	interlocking system, 2 x tray, 2 x tool holder, 2 x separators, rails for G-clamps set in the lid, metal hinges	interlocking system, 2 x tray, 2 x tool holder, 2 x separators, rails for G-clamps set in the lid, metal hinges	interlocking system, drawer, 2 x tray, 2 x tool holder, rails for G-clamps set in the lid, metal hinges



# X Block set modular system



new



KXB604040F

KXB604045F

X BLOCK LOG set	
	KXBS604085F
colour	S411
	mm 546 x 380 x 785
	kg ~
	pcs -
	pcs 8
	mm ~ 1720
	tool trolley, tool box



KXBA604030

KXBA604045

X BLOCK ALU LOG set	
	KXBAS604075
colour	S411
	mm 546 x 380 x 685
	kg ~
	pcs -
	pcs 8
	mm ~ 1530
	tool trolley, tool box



KXB604020

KXB604030

KXB604045

X BLOCK PRO set	
	KXBS604095
colour	S411
	mm 546 x 380 x 870
	kg ~
	pcs -
	pcs 8
	mm ~ 1890
	tool trolley, tool box, organiser



KXB604020

KXB604030CS

KXB604050

X BLOCK PRO set	
	KXBS6040100
colour	S411
	mm 546 x 380 x 970
	kg ~
	pcs -
	pcs 6
	mm ~ 1660
	tool trolley, basket, organiser

# X Block Bridge modular system

X Block Bridge is a smart connection way to combine X Block Series with MSX organisers



new



new



	X BLOCK BRIDGE organiser	X BLOCK BRIDGE organiser
	KXBB5540B	KXBB5540S
colour	S411	S411
mm	543 x 368 x 122	543 x 368 x 122
kg	~ 20	~ 20
pcs	5 / -	5 / -
pcs	50	50
mm	~ 1740	~ 1740
	interlocking base between X Block and MSX series, MSX locking system in polycarbonate lid, solid gasket, latches made of ABS with metal, 7 x boxes, 1 x MSX Box	interlocking base between X Block and MSX series, MSX locking system in polycarbonate lid, solid gasket, latches made of ABS with metal, 11 x separators, 2 x boxes



### X BLOCK BRIDGE MODULAR SYSTEM:

- Interlocking base to MSX system
- MSX locking system in lid
- Durable fasteners made of ABS with metal
- Additional MSX BOX organiser for storing small items
- Body made of a mixture of increased strength polymers
- Ergonomic handl
- Transparent polycarbonate lid
- Functional boxes and separators
- Lots of storage space

# X BLOCK BRIDGE organiser + MSX organiser



MSX organiser

X Block BRIDGE

X Block tool trolley



MSX locking system

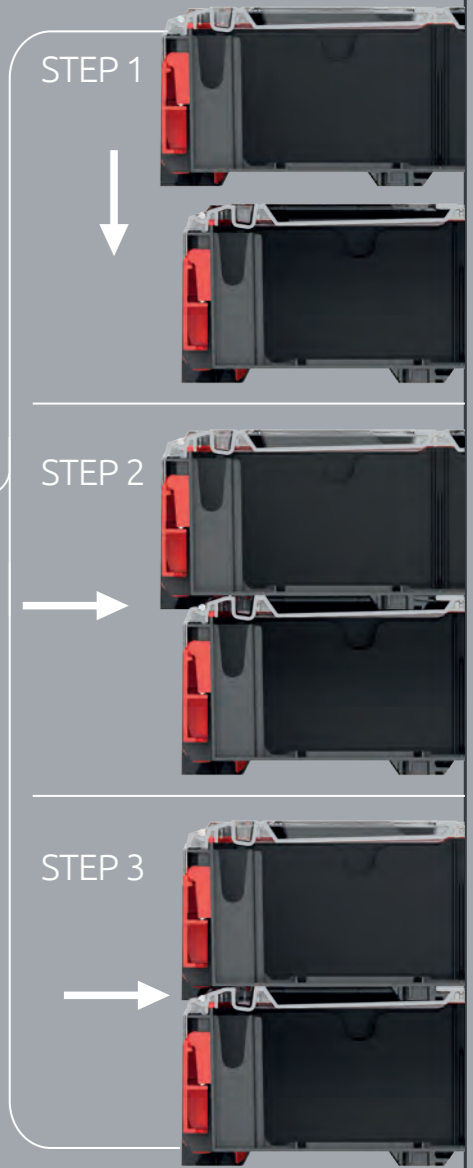



MSX organiser  
any model



X BLOCK BRIDGE  
organiser



MSX organiser  
any model



MSX ORGANISER

X Block Bridge is a smart connection  
way to combine X Block Series  
with MSX organisers



X Block  
PRO/LOG/TECH  
tool trolley  
any model



X Block BRIDGE  
organiser



Modular  
Solution  
tool box, tool trolley  
any model



X Block  
tool trolley



X Block BRIDGE  
organiser  
any model



X Block  
PRO/LOG/TECH  
tool trolley  
any model



Modular  
Solution  
tool box, tool trolley  
any model

easy  
to join

**X BLOCK** BRIDGE  
organiser



**MSX** ORGANISER

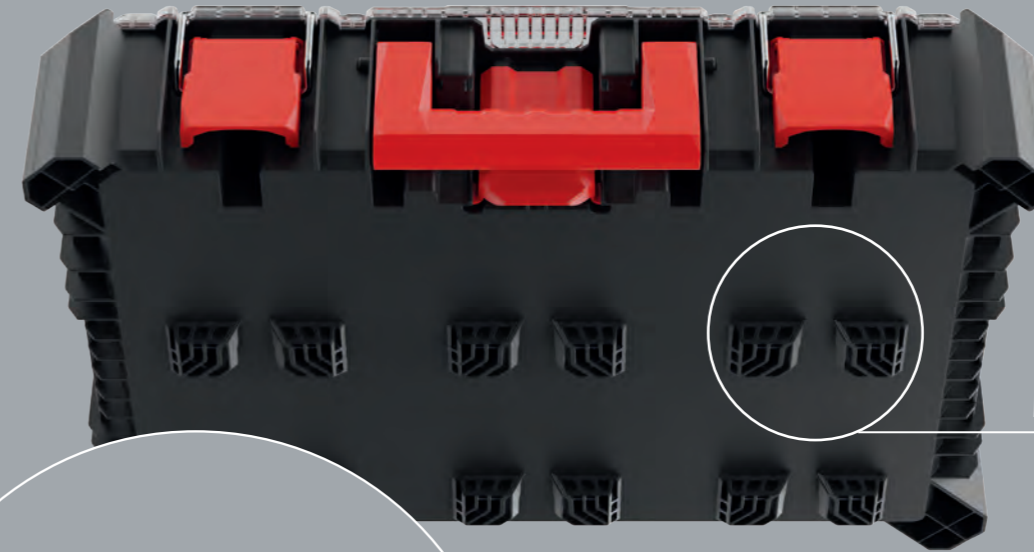

MSX locking system

**X BLOCK** BRIDGE is a smart connection way  
to combine **X Block** Series with **MSX**  
organisers



**MSX** locking system is a **NEW** connection  
system to combine 2 or more **MSX** organisers



# X Block Wagon PRO/TECH modular system



### X BLOCK WAGON:

- Very durable body with reinforced structure
- Two handles for easy transport
- Solid gasket ensures that the product is dustproof and water resistant
- Solid wheels with tread ensuring comfort of use
- Connectors for joining with X-Block system elements



	X BLOCK PRO wagon	X BLOCK TECH wagon
	KXB8040W	KXB8040WF
colour	S411	S411
mm	795 x 380 x 307	795 x 380 x 307
kg	~ 50	~ 50
	-	-
pcs	18	18
mm	~ 1920	~ 1920
	interlocking system, plain lid, metal hinges, 2 x separators, ABS latches	interlocking system, 4 x separators, g-clamps rails in the lid, metal hinges, ABS latches, organiser set in the lid

# X Block PRO modular system



### X BLOCK BASKET:

- Very durable body with reinforced structure
- Possibility of connecting and stacking with X-Block system elements
- Internal separators for customizing the interior space



	X BLOCK PRO basket	X BLOCK PRO basket	X BLOCK PRO basket
	KXB604030CS	KXB604020C	KXB604030C
colour	S411	S411	S411
mm	536 x 354 x 300	544 x 362 x 200	544 x 362 x 300
kg	~ 50	~ 25	~ 25
	3 / -	5 / -	5 / -
pcs	36	80	60
mm	~ 1950	~ 1680	~ 1700
	interlocking system - top, center, bottom, 2 x separators	interlocking system - top only, easy stackable - turn 180°	interlocking system - top only, easy stackable - turn 180°



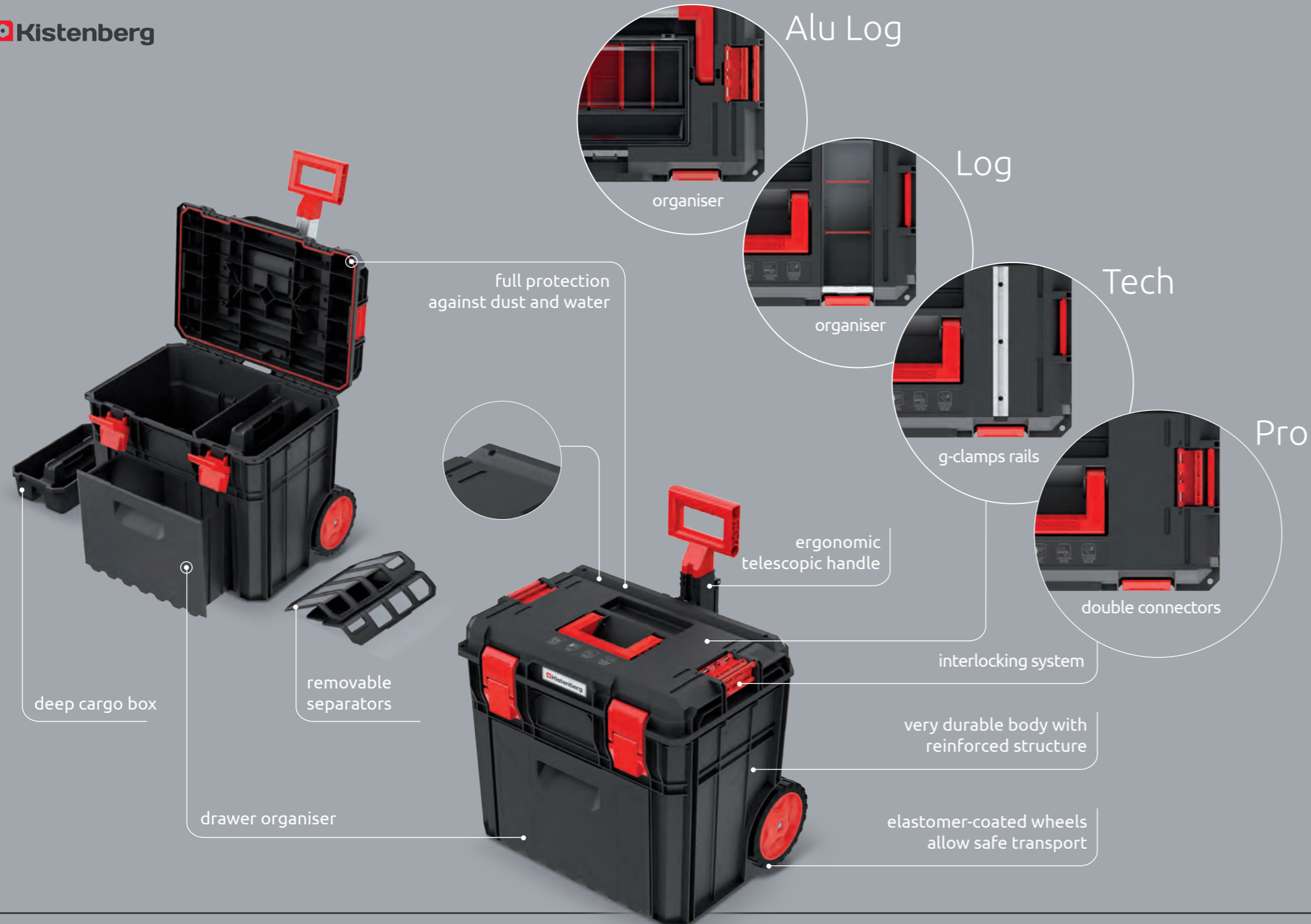

**Combine** any of Pro/ Log/ Alu Log/ Tech/ series and create your own unique set



## S Block PRO solid modular system



	S BLOCK PRO	S BLOCK PRO	S BLOCK PRO
	KXS4530	KXS5530	KXS6530
colour	S411	S411	S411
mm	450 x 280 x 264	550 x 280 x 264	650 x 280 x 314
kg	~ 30	~ 30	~ 30
pcs	-/-	-/-	-/-
pcs	52	42	30
mm	~ 1930	~ 1880	~ 1780
	interlocking system, plain lid, metal hinges, 1 x tray, 1 x separator, ABS latches	interlocking system, plain lid, metal hinges, 1 x tray, 2 x separators, ABS latches	interlocking system, plain lid, metal hinges, 1 x tray, 2 x separators, ABS latches
	compatible with: X Block Pro series, S Block Pro solid tool box KXS4530, S Block Alu Log solid tool box KXSA4530F	compatible with: X Block Pro series, S Block Pro solid tool box KXS5530, S Block Alu Log solid tool box KXSA5530F	compatible with: S Block Pro solid tool box KXS6530, S Block Alu Log solid tool box KXSA6530F

### S BLOCK PRO SOLID TOOL BOX:

- Solid gasket
- ABS latches
- Deep tray
- Removable separator



## S Block ALU LOG solid modular system



### S BLOCK ALU LOG SOLID TOOL BOX:

- Solid gasket
- ABS latches
- Deep tray
- Removable separator
- Polycarbonate cover
- Organizer with separators and boxes in the lid
- Aluminium handle



	S BLOCK ALU LOG	S BLOCK ALU LOG	S BLOCK ALU LOG
	KXSA4530F	KXSA5530F	KXSA6530F
colour	S411	S411	S411
mm	450 x 280 x 264	550 x 280 x 264	650 x 280 x 314
kg	~ 30	~ 30	~ 30
pcs	-/-	-/-	-/-
pcs	52	42	30
mm	~ 1930	~ 1880	~ 1880
	interlocking system, metal hinges, 1 x tray, 4 x separators, 4 x boxes	interlocking system, metal hinges, 1 x tray, 7 x separators, 4 x boxes	interlocking system, metal hinges, 1 x tray, 8 x separators, 4 x boxes
	compatible with: X Block Pro series, S Block Pro solid tool box KXS4530, S Block Alu Log solid tool box KXSA4530F	compatible with: X Block Pro series, S Block Pro solid tool box KXS5530, S Block Alu Log solid tool box KXSA5530F	compatible with: S Block Pro solid tool box KXS6530, S Block Alu Log solid tool box KXSA6530F





interlocking system

The cover of **X Block Pro** series has two additional built-in connectors with metal hinges to fasten:

- S Block Pro solid tool boxes
- X Block Alu Log solid tool boxes

The product is compatible with the Kistenberg KXS4530, KXSA4530F, KXS5530, KXSA5530F



interlocking system

**Combine** any of Pro/ Log/ Alu Log/ Tech/ series and create your own unique set

# Modular Solution modular system



	MODULAR SOLUTION organiser	MODULAR SOLUTION organiser	MODULAR SOLUTION tool box	MODULAR SOLUTION tool box
	KMS553515B	KMS553515S	KMS553530	KMS553530R2
colour	S411	S411	S411	S411
mm	517 x 331 x 134	517 x 331 x 134	530 x 355 x 310	530 x 355 x 310
kg	~ 20	~ 20	~ 50	~ 50
pcs	3/-	3/-	-	-
pcs	60	60	20	20
mm	~ 1800	~ 1800	~ 1670	~ 1670
	interlocking system, polycarbonate lid, ABS latches, 9 x boxes, metal hinges	interlocking system, polycarbonate lid, ABS latches, 11 x separators, metal hinges	interlocking system, ABS latches, 2 x separators	interlocking system, ABS latches, metal hinges, 2 x separators, 2 x organiser with polycarbonate lid



# Modular Solution modular system



interlocking system



set 4 in 1

	MODULAR SOLUTION tool trolley	MODULAR SOLUTION set
	KMS553540	KMS553585B
colour	S411	S411
mm	530 x 355 x 390	530 x 355 x 825
kg	~ 50	-
pcs	-	-
pcs	16	8
mm	~ 1750	~ 1770
	ABS latches, 2 x separators, tool holder, interlocking system, metal hinges	tool trolley with separators & removable tool holder, tool box with separators, ABS latches, organiser with removable boxes and polycarbonate lid



# Modular Solution modular system



	MODULAR SOLUTION basket	MODULAR SOLUTION basket	MODULAR SOLUTION basket	MODULAR SOLUTION basket
	KMS553510	KMS553510S	KMS553520	KMS553520S
colour	S411	S411	S411	S411
mm	520 x 327 x 125	520 x 327 x 125	520 x 329 x 210	520 x 329 x 210
kg	~ 50	~ 50	~ 50	~ 50
pcs	6 / -	6 / -	-	4 / -
pcs	60	60	32	32
mm	~ 1790	~ 1790	~ 1800	~ 1800
	interlocking system,	11 x separators, interlocking system,	interlocking system,	2 x separators, interlocking system,



# Modular Solution modular system



	MODULAR SOLUTION basket	MODULAR SOLUTION organiser	MODULAR SOLUTION tool holder
	KMS553520R7	KMS3020	KMS2530US
colour	S411	S411	S411
mm	520 x 329 x 210	294 x 194 x 60	304 x 85 x 333
kg	~ 50	-	-
pcs	-	10 / 40	- / 12
pcs	32	480	240
mm	~ 1800	~ 1920	~ 1850
	7 x organiser with polycarbonate lid, interlocking system, wall mountable	organiser with polycarbonate lid, ergonomic handle, 6 x separators	universal tool holder, ergonomic handle,



# MSX organiser modular system



new



new



new



new



	MSX organiser	MSX organiser	MSX organiser	MSX organiser
	KMX40258B	KMX402515B	KMX55408B	KMX554015B
	S411	S411	S411	S411
mm	368 x 228 x 77	368 x 228 x 126	543 x 390 x 77	543 x 368 x 126
kg	-	-	~ 20	~ 20
pcs	5 /-	5 /-	5 /-	5 /-
	200	125	80	50
mm	~ 1700	~ 1780	~ 1700	~ 1780
	MSX locking system, solid gasket, polycarbonate lid, 4 x boxes, metal hinges	MSX locking system, solid gasket, polycarbonate lid, 5 x boxes, 3 x separators, metal hinges	MSX locking system, polycarbonate lid, 7 x boxes, 1 x MSX Box organiser, 3 x separators, solid gasket, metal hinges, ABS latches with metal	MSX locking system, polycarbonate lid, 7 x boxes, 1 x MSX Box organiser, 4 x separators, solid gasket, metal hinges, ABS latches with metal

## MSX MODULAR SYSTEM ORGANISERS :

- Interlocking system for joining with MSX, X Block Bridge, Modular Solution series
- Durable latches made of ABS with metal
- Body made of a mixture of increased strength polymers
- Ergonomic handle
- Transparent polycarbonate lid
- Functional boxes and separators
- Additional organiser for storing small items
- Lots of storage space



# MSX organiser modular system



new



new



new



new



	MSX organiser	MSX organiser	MSX organiser	MSX organiser
	KMX40258S	KMX402515S	KMX55408S	KMX554015S
	S411	S411	S411	S411
mm	368 x 228 x 77	368 x 228 x 126	543 x 390 x 77	543 x 368 x 126
kg	-	-	~ 20	~ 20
pcs	5 /-	5 /-	5 /-	5 /-
	200	125	80	50
mm	~ 1700	~ 1780	~ 1700	~ 1780
	MSX locking system, metal hinges, solid gasket, polycarbonate lid, 3 x separators,	MSX locking system, metal hinges, solid gasket, polycarbonate lid, 3 x separators,	MSX locking system, metal hinges, polycarbonate lid, 2 x boxes, 11 x separators, solid gasket, ABS latches with metal	MSX locking system, metal hinges, polycarbonate lid, 2 x boxes, 11 x separators, solid gasket, ABS latches with metal



# MSX set organiser modular system



KMX55408B



KMX554015B



MSX locking system

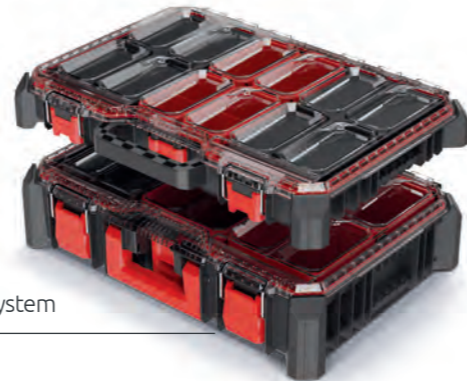

	MSX organiser set
	KMX55540B
colour	S411
	mm 543 x 390 x 200
	kg ~ 20 / 20
	pcs 3 / -
	pcs 36
	mm ~ 1950
	MSX locking system, set of 2 organisers, polycarbonate lid, 10 x boxes, 2 x MSX Box, 7 x separators

# MSX set organiser set modular system



KMX55408S



KMX554015S



MSX locking system



	MSX organiser set
	KMX55540S
colour	S411
	mm 543 x 390 x 200
	kg ~ 20 / 20
	pcs 3 / -
	pcs 36
	mm ~ 1950
	MSX locking system, set of 2 organisers, polycarbonate lid, ABS latches with metal, 18 x separators

easy to join

MSX  
organiser

X Block BRIDGE  
organiser

X Block  
tool box / tool trolley

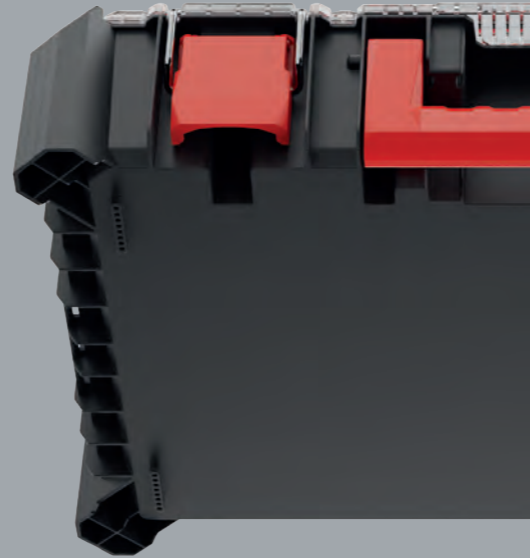

MSX  
organiser

Modular Solution  
tool box / tool trolley

CREATE YOUR OWN SET



MSX organiser  
any model

X Block BRIDGE  
any model

X Block PRO  
X Block LOG  
X Block TECH  
tool box  
tool trolley  
any model



MSX organiser  
any model

X Block BRIDGE  
any model

X Block PRO  
X Block LOG  
X Block TECH  
tool trolley  
any model



MSX organiser  
any model

X Block BRIDGE  
any model



MSX organiser  
any model



MSX organiser  
any model

Modular Solution  
tool box  
tool trolley  
any model



MSX organiser  
any model

Modular Solution  
tool box  
tool trolley  
any model



**X Block series**

**Modular Solution series**

easy  
to join



	<b>PLATFORM</b> transport platform
	KXBP6045
colour	S411
	mm 585 x 440 x 145
	kg ~ 100
	pcs - / 3
	pcs 42
	mm ~ 1930



# Platform

The Kistenberg Platform is compatible with **X Block**, **S Block Solid Tool box**, **Modular Solution**. Equipped with 4 fully rotating metal wheels for easy of movement ( two of which have been fitted with brakes). The solid ribbing design ensures a load capacity of up to 100 kg.

Product images are for illustrative purposes only and may differ from the actual product.



	<b>PLATFORM</b>
	KXBPFIX
colour	S411
	mm 585 x 440 x 70
	kg ~ 100
	pcs - / 5
	pcs 70
	mm ~ 1930

You craft, we store.



# Platform

The Kistenberg Platform is compatible with **X Block**, **S Block Solid Toolbox**, **Modular Solution**. Equipped with 4 mounting holes for easy mounting in a truck to prevent the boxes from overturning when driving. Compatible with KMS553520R7. Wall mountable.





# Heavy



- HEAVY TOOL TROLLEY:**
- Large wheels for easy transport of the box
  - Modular body made of reinforced polymer blend
  - Reinforced wall structure
  - Durable folding handle made of ABS
  - Durable ABS latches
  - Solid gasket ensures that the product is dustproof and water resistant
  - Functional tray inside
  - Transparent organizers with a polycarbonate covers
  - Separators and boxes in the organizer
  - Can be disassembled for transport



	HEAVY toll trolley	HEAVY toll trolley
	KHVW	KHVWM
colour	S411	S411
mm	450 x 360 x 640	450 x 360 x 640
kg	~ 25	~ 25
pcs	-	-
pcs	24	24
mm	~ 1670	~ 1670
	deep tray, ABS latches, compact packing 3in1	deep tray, metal latches, compact packing 3in1



# Heavy



- HEAVY:**
- Body made of reinforced polymer blend
  - Reinforced wall structure
  - Ergonomic ABS handles
  - Solid gasket ensures that the product is dustproof and water resistant
  - Functional storage space









	HEAVY organiser	HEAVY organiser	HEAVY tool box	HEAVY tool box
	KHV453520	KHV603520	KHV453535	KHV603535
colour	S411	S411	S411	S411
mm	445 x 360 x 216	585 x 360 x 217	445 x 360 x 337	585 x 360 x 337
kg	~ 25	~ 25	~ 25	~ 25
pcs	-	-	-	-
pcs	48	32	30	20
mm	~ 1840	~ 1840	~ 1800	~ 1800
	removable separators, 2 handles for easy carrying, two-component ABS latches, tool organiser set in the lid	removable separators, 2 handles for easy carrying, ABS latches, tool organiser set in the lid	ABS latches, deep tray	ABS latches, deep tray



# Heavy



	HEAVY organiser	HEAVY organiser	HEAVY tool box	HEAVY tool box
	KHV453520M	KHV603520M	KHV453535M	KHV603535M
colour	S411	S411	S411	S411
 mm	445 x 360 x 216	585 x 360 x 217	445 x 360 x 337	585 x 360 x 337
 kg	~ 25	~ 25	~ 25	~ 25
 pcs	-	-	-	-
 pcs	48	32	30	20
 mm	~ 1840	~ 1840	~ 1800	~ 1800
	removable separators, 2 handles for easy carrying, metal latches, tool organiser set in the lid	removable separators, 2 handles for easy carrying, metal latches, tool organiser set in the lid	metal latches, deep tray	metal latches, deep tray









## HEAVY:

- Body made of reinforced polymer blend
- Reinforced wall structure
- Ergonomic ABS handles
- Strong galvanized steel latches
- Solid gasket ensures that the product is dustproof and water resistant
- Functional storage space

# Heavy



	HEAVY organiser	HEAVY organiser
	KHV453520P	KHV603520P
colour	S411	S411
 mm	445 x 360 x 216	585 x 360 x 217
 kg	~ 25	~ 25
 pcs	-	-
 pcs	48	32
 mm	~ 1840	~ 1840
	foam inside, 2 handles for easy carrying, two-component ABS latches	foam inside, 2 handles for easy carrying, ABS latches



## HEAVY:

- Body made of reinforced polymer blend
- Reinforced wall structure
- Ergonomic ABS handles
- Durable ABS latches
- Gasket for water and dust resistance
- Functional storage space lined with foam

# Heavy



**HEAVY:**

- Body made of reinforced polymer blend
- Reinforced wall structure
- Ergonomic ABS handles
- Durable two-component latches made of ABS and elastomer
- Solid gasket ensures that the product is dustproof and water resistant
- Functional storage space



	HEAVY tool box	HEAVY tool box
	KHV453535O	KHV603535O
colour	S411	S411
mm	445 x 360 x 337	585 x 360 x 337
kg	~ 25	~ 25
pcs	-	-
pcs	30	20
mm	~ 1800	~ 1800
	ABS latches, tool organiser set in the lid	ABS latches, tool organiser set in the lid



# Heavy

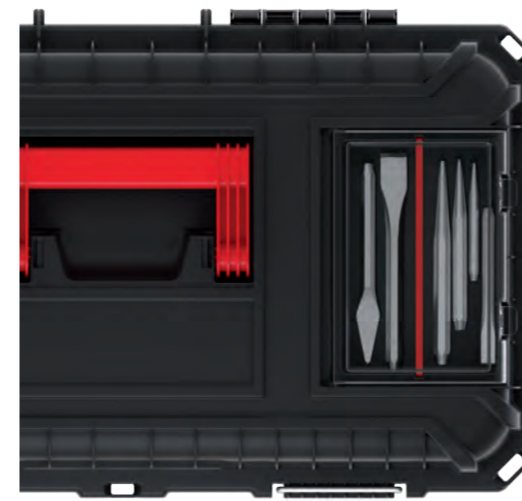

**HEAVY:**

- Body made of reinforced polymer blend
- Reinforced wall structure
- Ergonomic ABS handles
- Durable ABS latches
- Dustproof and water resistant thanks to a solid gasket
- Functional tray



	HEAVY tool box	HEAVY tool box	HEAVY tool box	HEAVY tool box
	KHV453535F	KHV603535F	KHV453535FM	KHV603535FM
colour	S411	S411	S411	S411
mm	445 x 360 x 337	585 x 360 x 337	445 x 360 x 337	585 x 360 x 337
kg	~ 25	~ 25	~ 25	~ 25
pcs	-	-	-	-
pcs	30	20	30	20
mm	~ 1800	~ 1800	~ 1800	~ 1800
	plastic handle, separators, ABS latches, organiser with polycarbonate cover set in the lid, deep tray		plastic handle, separators, metal latches, organiser with polycarbonate cover set in the lid, deep tray	



# Heavy



	HEAVY tool box	HEAVY tool box	HEAVY tool box	HEAVY tool box
	KHVA453535BS	KHVA603535BS	KHVA453535BSM	KHVA603535BSM
colour	S411	S411	S411	S411
mm	445 x 360 x 337	585 x 360 x 337	445 x 360 x 337	585 x 360 x 337
kg	~ 25	~ 25	~ 25	~ 25
pcs	-	-	-	-
pcs	30	20	30	20
mm	~ 1800	~ 1800	~ 1800	~ 1800
	deep tray, alu handle, ABS latches, organiser set in the lid with separators and boxes, polycarbonate cover		deep tray, alu handle, metal latches, organiser set in the lid with separators and boxes, polycarbonate cover	



**HEAVY:**

- Body made of reinforced polymer blend
- Reinforced wall structure
- Durable large aluminum handle
- Durable ABS latches
- Dustproof and water resistant thanks to a solid gasket
- Functional tray inside
- Large transparent organizer with a polycarbonate covers
- Separators and boxes in the organizer

# Heavy



	HEAVY organiser	HEAVY organiser	HEAVY organiser	HEAVY organiser
	KHV40	KHV40P	KHV40S	KHV40B
colour	S411	S411	S411	S411
mm	384 x 335 x 144	384 x 335 x 144	384 x 335 x 144	384 x 335 x 144
kg	-	-	-	-
pcs	4/-	4/-	4/-	4/-
pcs	80	80	80	80
mm	~ 1790	~ 1790	~ 1790	~ 1790
	fastening belts inside, ergonomic handle	foam inside, ergonomic handle	organiser set in the lid with separators and polycarbonate cover	organiser set in the lid with boxes and polycarbonate cover



**HEAVY:**

- Body made of a mixture of increased strength polymers
- Ergonomic handle
- Ergonomic fasteners

# Titan Plus tool box

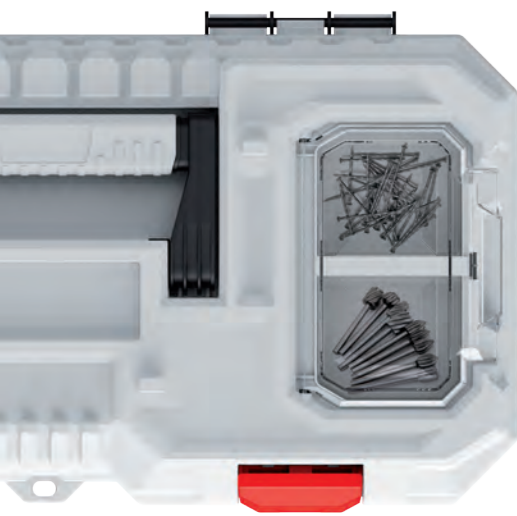

**TITAN PLUS:**

- Body made of a durable polymer blend
- Ergonomic handle
- Durable ABS latches
- Transparent organizers with a polycarbonate lids
- Elastomer corners
- Inner tray



	TITAN PLUS tool box	TITAN PLUS tool box
	KTIP5025	KTIP5530
colour	<span style="background-color: red; color: white; padding: 2px;">3020</span> <span style="border: 1px solid gray; padding: 2px;">4C</span>	<span style="background-color: red; color: white; padding: 2px;">3020</span> <span style="border: 1px solid gray; padding: 2px;">4C</span>
mm	496 x 258 x 240	554 x 286 x 276
kg	~ 15	~ 20
pcs	-	-
pcs	52	36
mm	~ 1830	~ 1800
	two-component handle, ABS latches, rubber corners	two-component handle, ABS latches, rubber corners



# Titan Plus tool box

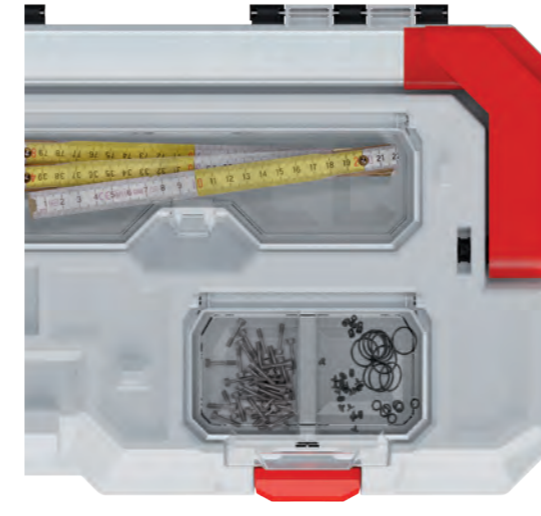

**TITAN PLUS:**

- Body made of a durable polymer blend
- Durable aluminum handle
- Durable ABS latches
- Transparent organizers with a polycarbonate covers
- Elastomer corners
- Inner tray
- Large capacity

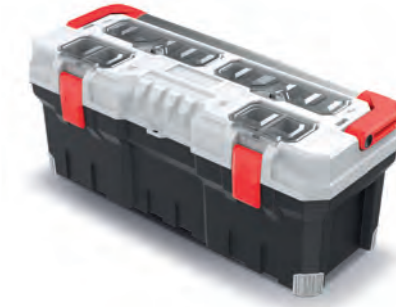

	TITAN PLUS tool box	TITAN PLUS tool box	TITAN PLUS tool box
	KTIPA5025	KTIPA5530	KTIPA7530
colour	<span style="background-color: red; color: white; padding: 2px;">3020</span> <span style="border: 1px solid gray; padding: 2px;">4C</span>	<span style="background-color: red; color: white; padding: 2px;">3020</span> <span style="border: 1px solid gray; padding: 2px;">4C</span>	<span style="background-color: red; color: white; padding: 2px;">3020</span> <span style="border: 1px solid gray; padding: 2px;">4C</span>
mm	496 x 258 x 240	554 x 286 x 276	752 x 300 x 304
kg	~ 15	~ 20	~ 30
pcs	-	-	-
pcs	52	36	20
mm	~ 1830	~ 1800	~ 1670
	alu handle, ABS latches, rubber corners	alu handle, ABS latches, rubber corners	alu handle, ABS latches, rubber corners



## Optima tool box



new

new

new

new

	OPTIMA tool box	OPTIMA tool box	OPTIMA tool box	OPTIMA tool box	OPTIMA tool box	OPTIMA tool box
	KOP3020N	KOP3020	KOP4020N	KOP4020	KOP5025	KOP5530
colour	4C	4C	4C	4C	4C	4C
mm	296 x 178 x 153	296 x 178 x 153	360 x 195 x 183	360 x 195 x 183	470 x 256 x 238	540 x 278 x 269
kg	~ 10	~ 10	~ 10	~ 10	~ 13	~ 20
pcs	-	-	-	-	-	-
pcs	216	216	108	108	52	36
mm	~ 1940	~ 1940	~ 1770	~ 1770	~ 1860	~ 1700
	plastic handle, tray	organiser in the lid, plastic handle, tray	plastic handle, tray	organiser in the lid, plastic handle, tray	organiser in the lid, plastic handle, tray, two-component ABS latches,	organiser in the lid, plastic handle, tray, two-component ABS latches,

### OPTIMA:

- Body made of a mixture of increased strength polymers
- Organizers with durable polycarbonate lids
- Functional tray inside
- Ergonomic handle



## Optima tool box



### OPTIMA:

- Body made of a mixture of increased strength polymers
- Transparent organizers with a polycarbonate cover
- Functional tray inside
- Solid, ergonomic aluminum handle
- Durable two-component fasteners made of ABS and elastomer



OPTIMA tool box

OPTIMA tool box

OPTIMA tool box

	OPTIMA tool box	OPTIMA tool box	OPTIMA tool box
	KOPA5025	KOPA5530	KOPA6030
colour	4C	4C	4C
mm	470 x 256 x 238	540 x 278 x 269	586 x 296 x 305
kg	~ 13	~ 20	~ 25
pcs	-	-	-
pcs	52	36	36
mm	~ 1860	~ 1700	~ 1930
	organiser in the lid, alu handle, tray, two-component ABS latches,	organiser in the lid, alu handle, tray, two-component ABS latches,	organiser in the lid, alu handle, tray, two-component ABS latches,



# Optima tool box



	OPTIMA tool box	OPTIMA tool box	OPTIMA tool box
	KOPA5025S	KOPA5530S	KOPA6030S
colour	4C	4C	4C
mm	470 x 256 x 238	540 x 278 x 269	586 x 296 x 305
kg	~ 13	~ 20	~ 25
pcs	-	-	-
pcs	52	36	36
mm	~ 1860	~ 1700	~ 1930
i	organiser in the lid, alu handle, tray, two-component ABS latches,	organiser in the lid, alu handle, tray, two-component ABS latches,	organiser in the lid, alu handle, tray, two-component ABS latches,

**OPTIMA:**

- Body made of a mixture of increased strength polymers
- Large organizer with partitions and a durable polycarbonate lid
- Functional tray inside
- Solid, ergonomic aluminum handle
- Durable two-component latches made of ABS and elastomer



# Optima tool box



	OPTIMA tool box	OPTIMA tool box	OPTIMA tool box
	KOPA5025SM	KOPA5530SM	KOPA6030SM
colour	4C	4C	4C
mm	470 x 256 x 238	540 x 278 x 269	586 x 296 x 305
kg	~ 13	~ 20	~ 25
pcs	-	-	-
pcs	52	36	36
mm	~ 1860	~ 1700	~ 1930
i	organiser with separators in the lid, alu handle, metal latches, tray	organiser with separators in the lid, alu handle, metal latches, tray	organiser with separators in the lid, alu handle, metal latches, tray

**OPTIMA:**

- Body made of a mixture of increased strength polymers
- Large organizer with separators and a durable polycarbonate lid
- Functional tray inside
- Solid, ergonomic aluminum handle
- Durable galvanized steel latches



# Optima tool box



	OPTIMA tool box	OPTIMA tool box	OPTIMA tool box
	KOPA5025B	KOPA5530B	KOPA6030B
colour	4C	4C	4C
mm	470 x 256 x 238	540 x 278 x 269	586 x 296 x 305
kg	~ 13	~ 20	~ 25
pcs	-	-	-
pcs	52	36	36
mm	~ 1860	~ 1700	~ 1930
i	organiser in the lid, alu handle, tray, two-component ABS latches	organiser in the lid, alu handle, tray, two-component ABS latches	organiser in the lid, alu handle, tray, two-component ABS latches



**OPTIMA:**

- Body made of a mixture of increased strength polymers
- Large organizer with boxes and a durable polycarbonate lid
- Functional tray inside
- Durable, ergonomic aluminum handle
- Durable two-component latches made of ABS and elastomer

# Optima tool box



	OPTIMA tool box	OPTIMA tool box	OPTIMA tool box
	KOPA5025BM	KOPA5530BM	KOPA6030BM
colour	4C	4C	4C
mm	470 x 256 x 238	540 x 278 x 269	586 x 296 x 305
kg	~ 13	~ 20	~ 25
pcs	-	-	-
pcs	52	36	36
mm	~ 1860	~ 1700	~ 1930
i	organiser in the lid, alu handle, tray, metal latches	organiser in the lid, alu handle, tray, metal latches	organiser in the lid, alu handle, tray, metal latches



**OPTIMA:**

- Body made of a mixture of increased strength polymers
- Large organizer with boxes and a durable polycarbonate lid
- Functional tray inside
- Solid, ergonomic aluminum handle
- Durable galvanized steel latches



# Evo tool box



	new EVO tool box	new EVO tool box	new EVO tool box	new EVO tool box	EVO tool box	EVO tool box
	KEV3020N	KEV3020	KEV4020N	KEV4020	KEV5025	KEV5530
colour	3020	3020	3020	3020	3020	3020
mm	269 x 177 x 155	269 x 177 x 155	360 x 193 x 186	360 x 193 x 186	476 x 260 x 256	548 x 274 x 286
kg	~ 10	~ 10	~ 10	~ 10	~ 12	~ 20
pcs	-	-	-	-	-	-
pcs	216	216	108	108	52	36
mm	~ 1940	~ 1940	~ 1770	~ 1770	~ 1880	~ 1820
i	ABS latches, tray	organiser in the lid, tray, ABS latches	ABS latches, tray	organiser with separators in the lid, tray, ABS latches	organiser with separators in the lid, tray, ABS latches	organiser with separators in the lid, tray, ABS latches



# Evo tool box



- EVO:**
- Body made of a mixture of increased strength polymers
  - Organizers with separators and durable polycarbonate lids
  - Functional tray inside
  - Ergonomic handle
  - Durable aluminum latches

Product images are for illustrative purposes only and may differ from the actual product.

**You craft, we store.**



	EVO tool box	EVO tool box
	KEV5025AL	KEV5530AL
colour	3020	3020
mm	476 x 260 x 256	548 x 274 x 286
kg	~ 12	~ 20
pcs	-	-
pcs	52	36
mm	~ 1880	~ 1820
i	organiser with separators in the lid, tray, alu latches	organiser with separators in the lid, tray, alu latches



# Evo tool box



	EVO tool box	EVO tool box	EVO tool box
	KEVA5025S	KEVA5530S	KEVA6030S
colour	3020	3020	3020
mm	476 x 260 x 256	548 x 274 x 286	595 x 288 x 308
kg	~ 12	~ 20	~ 25
pcs	-	-	-
pcs	52	36	36
mm	~ 1880	~ 1820	~ 1940
i	organiser with separators in the lid, alu handle, tray, ABS latches	organiser with separators in the lid, alu handle, tray, ABS latches	organiser with separators in the lid, alu handle, tray, ABS latches



**EVO:**

- Body made of a mixture of increased strength polymers
- Large organizer with separators and a durable polycarbonate lid
- Functional tray inside
- Solid, ergonomic aluminum handle
- Durable ABS latches

Product images are for illustrative purposes only and may differ from the actual product.

# Evo tool box



	EVO tool box	EVO tool box	EVO tool box
	KEVA5025SAL	KEVA5530SAL	KEVA6030SAL
colour	3020	3020	3020
mm	476 x 260 x 256	548 x 274 x 286	595 x 288 x 308
kg	~ 12	~ 20	~ 25
pcs	-	-	-
pcs	52	36	36
mm	~ 1880	~ 1820	~ 1940
i	organiser with separators in the lid, alu handle, tray, alu latches	organiser with separators in the lid, alu handle, tray, alu latches	organiser with separators in the lid, alu handle, tray, alu latches



**EVO:**

- Body made of a mixture of increased strength polymers
- Large organizer with separators and a durable polycarbonate lid
- Functional tray inside
- Solid, ergonomic aluminum handle
- Durable aluminium latches

Product images are for illustrative purposes only and may differ from the actual product.

# Evo tool box



	EVO tool box	EVO tool box	EVO tool box
	KEVA5025B	KEVA5530B	KEVA6030B
colour	3020	3020	3020
mm	476 x 260 x 256	548 x 274 x 286	595 x 288 x 308
kg	~ 12	~ 20	~ 25
pcs	-	-	-
pcs	52	36	36
mm	~ 1880	~ 1820	~ 1940
i	organiser with boxes in the lid, alu handle, tray, ABS latches	organiser with boxes in the lid, alu handle, tray, ABS latches	organiser with boxes in the lid, alu handle, tray, ABS latches



**EVO:**

- Body made of a mixture of increased strength polymers
- Large organizer with boxes and a durable polycarbonate lid
- Functional tray inside
- Solid, ergonomic aluminum handle
- Durable ABS latches

Product images are for illustrative purposes only and may differ from the actual product.

# Evo tool box



	EVO tool box	EVO tool box	EVO tool box
	KEVA5025BAL	KEVA5530BAL	KEVA6030BAL
colour	3020	3020	3020
mm	476 x 260 x 256	548 x 274 x 286	595 x 288 x 308
kg	~ 12	~ 20	~ 25
pcs	-	-	-
pcs	52	36	36
mm	~ 1880	~ 1820	~ 1940
i	organiser with boxes in the lid, alu handle, tray, alu latches	organiser with boxes in the lid, alu handle, tray, alu latches	organiser with boxes in the lid, alu handle, tray, alu latches



**EVO:**

- Body made of a mixture of increased strength polymers
- Large organizer with boxes and a durable polycarbonate lid
- Functional tray inside
- Solid, ergonomic aluminum handle
- Durable aluminium latches

Product images are for illustrative purposes only and may differ from the actual product.

# Aptop PLUS tool box



	APTOP PLUS tool box	APTOP PLUS tool box	APTOP PLUS tool box
	KAP5025AL	KAP5530AL	KAP6030AL
	<b>3020</b>	<b>3020</b>	<b>3020</b>
	mm 458 x 257 x 245	mm 550 x 267 x 277	mm 598 x 286 x 327
	kg ~ 13	kg ~ 20	kg ~ 25
	pcs -	pcs -	pcs -
	pcs 52	pcs 42	pcs 30
	mm ~ 1850	mm ~ 1800	mm ~ 1750
	aluminium latches, anodised aluminium handle, long tray inside, transparent polycarbonate organisers set in the lid, loop for a lock	aluminium latches, anodised aluminium handle, long tray inside, transparent polycarbonate organisers set in the lid, loop for a lock	aluminium latches, anodised aluminium handle, long tray inside, transparent polycarbonate organisers set in the lid, loop for a lock

**APTOP PLUS:**

- Body made of a mixture of increased strength polymers
- Large organizer with boxes and a durable polycarbonate lid
- Functional tray inside
- Solid, ergonomic aluminum handle
- Aluminium handle



# Caliber tool box



	CALIBER tool box	CALIBER tool box	CALIBER tool box	CALIBER tool box	CALIBER tool box
	KCR3020	KCR4020	KCR5025	KCR5530	KCR6030
	<b>S411</b>	<b>S411</b>	<b>S411</b>	<b>S411</b>	<b>S411</b>
	mm 300 x 167 x 150	mm 400 x 200 x 186	mm 460 x 257 x 227	mm 550 x 267 x 270	mm 597 x 285 x 320
	kg ~ 6	kg ~ 8,5	kg ~ 11,5	kg ~ 19,0	kg ~ 21,0
	pcs -	pcs -	pcs -	pcs -	pcs -
	pcs 240	pcs 108	pcs 60	pcs 42	pcs 30
	mm ~ 1930	mm ~ 1810	mm ~ 1950	mm ~ 1750	mm ~ 1720
	plastic handle, plastic latches, tray inside, loop for a lock	plastic handle, plastic latches, tray inside, loop for a lock	plastic handle, plastic latches, tray inside, loop for a lock	transparent organisers set in the lid, tray inside, loop for a lock	transparent organisers set in the lid, tray inside, loop for a lock

**CALIBER:**

- Body made of a mixture of increased strength polymers
- Organizers with transparent lids
- Functional tray inside
- Ergonomic handle



# Smart tool box



**SMART:**

- Modern design
- Ergonomic handle
- Durable ABS fasteners
- Inner tray



	SMART tool box	SMART tool box	SMART tool box	SMART tool box set
	KSM32	KSM40	KSM50	KSMS40
colour	<span style="background-color: red; color: white; padding: 2px;">3020</span> <span style="border: 1px solid gray; padding: 2px;">4C</span>	<span style="background-color: red; color: white; padding: 2px;">3020</span> <span style="border: 1px solid gray; padding: 2px;">4C</span>	<span style="background-color: red; color: white; padding: 2px;">3020</span> <span style="border: 1px solid gray; padding: 2px;">4C</span>	<span style="background-color: red; color: white; padding: 2px;">3020</span> <span style="border: 1px solid gray; padding: 2px;">4C</span>
mm	328 x 178 x 160	380 x 234 x 225	500 x 251 x 243	380 x 234 x 225
kg	~ 6	~ 8,5	~ 12	~ 6 / ~ 8,5
pcs	-	-	-	-
pcs	154	80	49	80
mm	~ 1880	~ 1900	~ 1800	~ 1900
	ABS latches, ergonomic handle, tray	ABS latches, ergonomic handle, tray	ABS latches, ergonomic handle, tray	ABS latches, ergonomic handle, smart set 2in1, trays



	SMART tool box	SMART tool box	SMART tool box	SMART tool box	SMART tool box
	KSML32 - K1	KSML40 - K1	KSML32 - K2	KSML40 - K2	KSMA50F
colour	<span style="border: 1px solid gray; padding: 2px;">4C</span>	<span style="border: 1px solid gray; padding: 2px;">4C</span>	<span style="border: 1px solid gray; padding: 2px;">4C</span>	<span style="border: 1px solid gray; padding: 2px;">4C</span>	<span style="background-color: red; color: white; padding: 2px;">3020</span> <span style="border: 1px solid gray; padding: 2px;">4C</span>
mm	328 x 178 x 160	380 x 234 x 225	328 x 178 x 160	380 x 234 x 225	500 x 251 x 243
kg	~ 6	~ 8,5	~ 6	~ 8,5	~ 12
pcs	-	-	-	-	-
pcs	154	80	154	80	49
mm	~ 1880	~ 1900	~ 1880	~ 1900	~ 1810
	ABS latches, ergonomic handle, tray, IML lid	ABS latches, ergonomic handle, tray, IML lid	ABS latches, ergonomic handle, tray, IML lid	ABS latches, ergonomic handle, tray, IML lid	ABS latches, ergonomic alu handle, tray, organiser with boxes in the lid

**SMART:**

- Modern personalized design
- Ergonomic handle
- Durable ABS fasteners
- Inner tray



K1



K2



# Cargo PLUS tool tray



	CARGO PLUS tool tray			CARGO PLUS tool tray		
	KCA30	KCA40	KCA50	KCA30S	KCA40S	KCA50S
colour	S411	S411	S411	S411	S411	S411
mm	300 x 300 x 133	395 x 295 x 190	495 x 345 x 210	300 x 300 x 133	395 x 295 x 190	495 x 345 x 210
kg	-	-	-	-	-	-
pcs	10 / 40	12 / 24	- / 12	10 / 40	12 / 24	- / 12
pcs	400	288	144	400	288	144
mm	~ 1700	~ 1860	~ 1700	~ 1700	~ 1860	~ 1700
	ergonomic handle	ergonomic handle	ergonomic handle	ergonomic handle, separators	ergonomic handle, separators	ergonomic handle, separators



**CARGO:**

- Body made of a mixture of increased strength polymers
- Spacious chambers
- Ergonomic handle
- Functional partitions

# Cargo tool tray



**CARGO:**

- Body made of a mixture of increased strength polymers
- Spacious chambers
- Ergonomic handle made of anodized aluminum



	CARGO tool tray	CARGO tool tray
	KCAA40	KCAA50
colour	S411	S411
mm	400 x 220 x 170	496 x 296 x 231
kg	-	-
pcs	- / 38	- / 8
pcs	608	96
mm	~ 1950	~ 1700
	alu handle	alu handle



# Titan organiser



	TITAN organiser	TITAN organiser	TITAN organiser
	KTI3030S	KTI4040S	KTI6040S
	<b>CG6U</b>	<b>CG6U</b>	<b>CG6U</b>
	mm 280 x 280 x 110	mm 390 x 390 x 110	mm 598 x 390 x 110
	kg ~ 10	kg ~ 20	kg ~ 20
	pcs 6 / 12	pcs 5 / -	pcs 5 / -
	pcs 144	pcs 90	pcs 60
	mm ~ 1860	mm ~ 1800	mm ~ 1800
	polycarbonate lid, plastic handle, separators, rubber corners	polycarbonate lid, plastic handle, separators, rubber corners	polycarbonate lid, plastic handle, separators, rubber corners



- TITAN:**
- Durable polymer blend body
  - Elastomer corners
  - Ergonomic handle
  - Mechanically resistant polycarbonate lid
  - ABS fasteners
  - Functional separators

# Titan organiser



	TITAN organiser	TITAN organiser	TITAN organiser
	KTI3030B	KTI4040B	KTI6040B
	<b>CG6U</b>	<b>CG6U</b>	<b>CG6U</b>
	mm 280 x 280 x 110	mm 390 x 390 x 110	mm 598 x 390 x 110
	kg ~ 10	kg ~ 20	kg ~ 20
	pcs 6 / 12	pcs 5 / -	pcs 5 / -
	pcs 144	pcs 90	pcs 60
	mm ~ 1860	mm ~ 1800	mm ~ 1800
	polycarbonate lid, plastic handle, boxes, rubber corners	polycarbonate lid, plastic handle, boxes, rubber corners	polycarbonate lid, plastic handle, boxes, rubber corners



- TITAN:**
- Durable polymer blend body
  - Elastomer corners
  - Ergonomic handle
  - Mechanically resistant polycarbonate lid
  - ABS fasteners
  - Functional bins

Product images are for illustrative purposes only and may differ from the actual product.



You craft, we store.

# Titan organiser

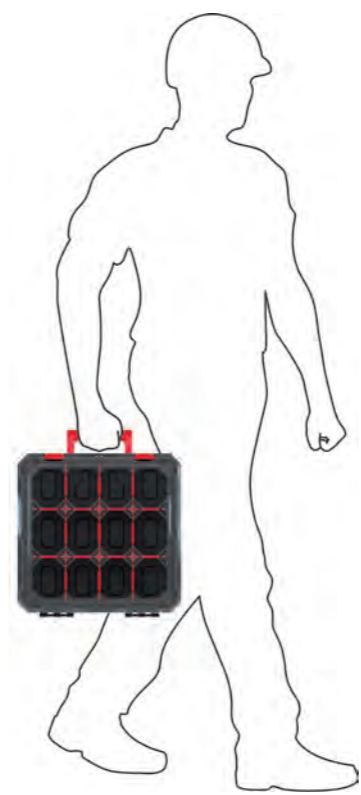

- TITAN:**
- Durable polymer blend body
  - Elastomer corners
  - Ergonomic handle
  - Mechanically resistant polycarbonate lid
  - ABS fasteners
  - Functional separators and bins

Product images are for illustrative purposes only and may differ from the actual product.

You craft, we store.



TITAN organiser

KT14040BS

**CG6U**

	mm	390 x 390 x 110
	kg	~ 20
	pcs	5 / -
	pcs	90
	mm	~ 1800
	polycarbonate lid, mix of boxes and separators, rubber corners	





# Tager Carbo Plus

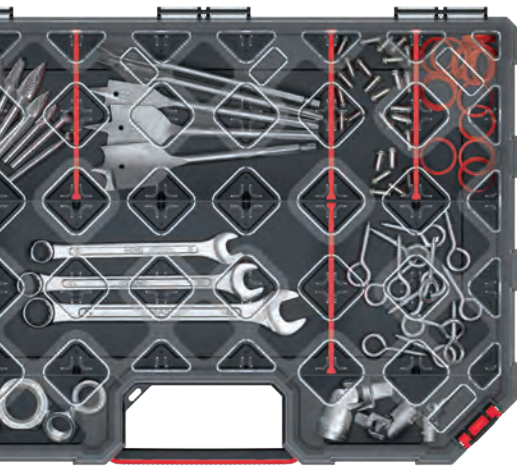

	TAGER CARBO PLUS organiser	TAGER CARBO PLUS organiser	TAGER CARBO PLUS organiser
	KTGC30256S	KTGC40306S	KTGC60406S
colour	CG6U	CG6U	CG6U
mm	284x243x60	390x284x60	577x390x60
kg	-	-	-
pcs	10 /-	5 /-	5 /-
pcs	360	240	120
mm	~ 1900	~ 1920	~ 1850
i	polycarbonate lid, separators, two-component handle	polycarbonate lid, separators, two-component handle	polycarbonate lid, separators, two-component handle



**TAGER:**

- Body made of a mixture of increased strength polymers
- Ergonomic handle
- Transparent polycarbonate lid
- Functional partitions
- Durable fasteners

# Tager Carbo Plus

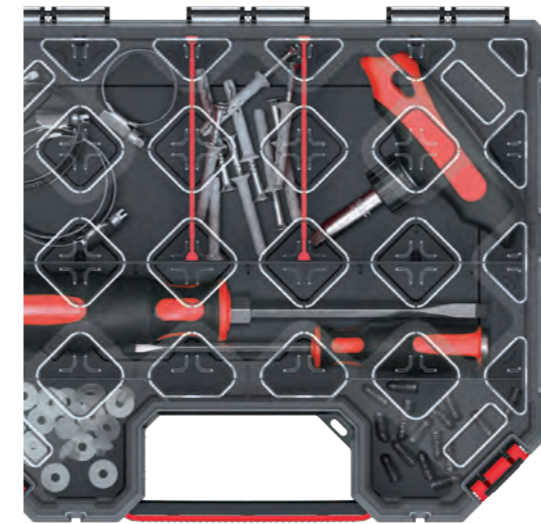

	TAGER CARBO PLUS organiser	TAGER CARBO PLUS organiser	TAGER CARBO PLUS organiser
	KTGC302510S	KTGC403010S	KTGC604010S
colour	CG6U	CG6U	CG6U
mm	284 x 243 x 105	390 x 284 x 105	577 x 390 x 105
kg	-	-	-
pcs	5 /-	5 /-	5 /-
pcs	180	120	60
mm	~ 1680	~ 1700	~ 1770
i	polycarbonate lid, separators, two-component handle	polycarbonate lid, separators, two-component handle	polycarbonate lid, separators, two-component handle



**TAGER:**

- Body made of a mixture of increased strength polymers
- Ergonomic handle
- Transparent polycarbonate lid
- Functional partitions
- Durable fasteners
- Lots of storage space

# Tager Carbo Plus

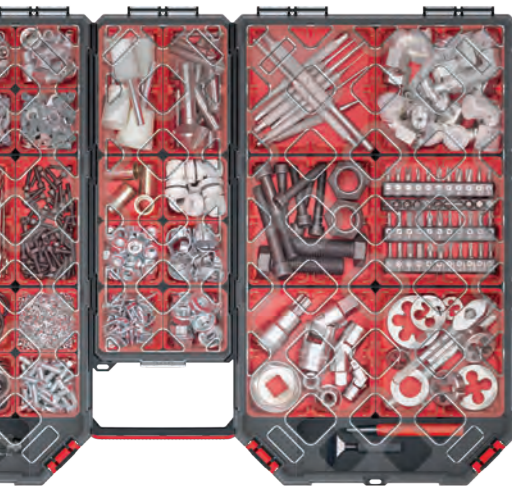

	TAGER CARBO PLUS organiser	TAGER CARBO PLUS organiser	TAGER CARBO PLUS organiser
	KTGC30256B	KTGC40306B	KTGC60406B
colour	<span style="border: 1px solid black; padding: 1px;">CG6U</span>	<span style="border: 1px solid black; padding: 1px;">CG6U</span>	<span style="border: 1px solid black; padding: 1px;">CG6U</span>
mm	284x243x60	390x284x60	577x390x60
kg	-	-	-
pcs	10 /-	5 /-	5 /-
pcs	360	240	120
mm	~ 1900	~ 1920	~ 1850
	polycarbonate lid, boxes, two-component handle	polycarbonate lid, boxes, two-component handle	polycarbonate lid, boxes, two-component handle



**TAGER:**

- Body made of a mixture of increased strength polymers
- Ergonomic handle
- Transparent polycarbonate lid
- Functional bins
- Durable fasteners
- Lots of storage space

# Tager Carbo Plus

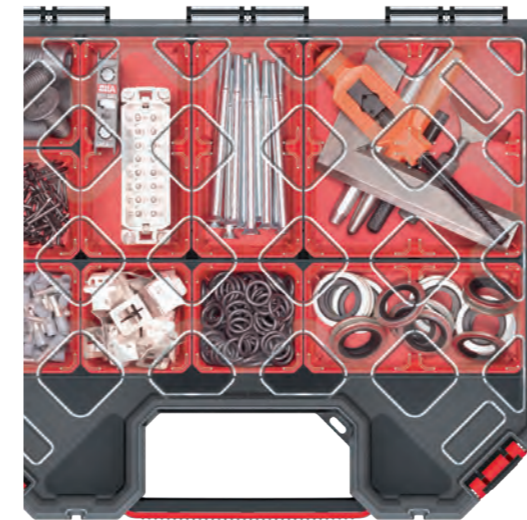

	TAGER CARBO PLUS organiser	TAGER CARBO PLUS organiser	TAGER CARBO PLUS organiser
	KTGC302510B	KTGC403010B	KTGC604010B
colour	<span style="border: 1px solid black; padding: 1px;">CG6U</span>	<span style="border: 1px solid black; padding: 1px;">CG6U</span>	<span style="border: 1px solid black; padding: 1px;">CG6U</span>
mm	284 x 243 x 105	390 x 284 x 105	577 x 390 x 105
kg	-	-	-
pcs	5 /-	5 /-	5 /-
pcs	180	120	60
mm	~ 1680	~ 1700	~ 1770
	polycarbonate lid, boxes, two-component handle	polycarbonate lid, boxes, two-component handle	polycarbonate lid, boxes, two-component handle



**TAGER:**

- Body made of a mixture of increased strength polymers
- Ergonomic handle
- Transparent polycarbonate lid
- Functional bins
- Durable fasteners
- Lots of storage space

# Tager Carbo Plus

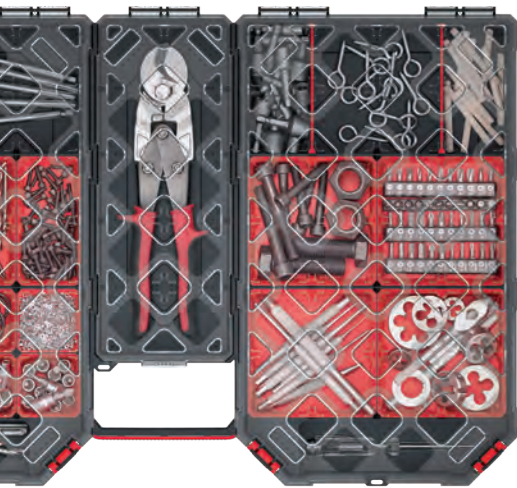

	TAGER CARBO PLUS organiser	TAGER CARBO PLUS organiser	TAGER CARBO PLUS organiser
	KTGC30256BS	KTGC40306BS	KTGC60406BS
colour	<span style="border: 1px solid black; padding: 1px;">CG6U</span>	<span style="border: 1px solid black; padding: 1px;">CG6U</span>	<span style="border: 1px solid black; padding: 1px;">CG6U</span>
mm	284x243x60	390x284x60	577x390x60
kg	-	-	-
pcs	10 /-	5 /-	5 /-
pcs	360	240	120
mm	~ 1900	~ 1920	~ 1850
	polycarbonate lid, mix of separators and boxes, two-component handle	polycarbonate lid, mix of separators and boxes, two-component handle	polycarbonate lid, mix of separators and boxes, two-component handle

**TAGER:**

- Body made of a mixture of increased strength polymers.
- Ergonomic handle.
- Transparent polycarbonate lid.
- Functional bins and partitions.
- Durable fasteners.
- Lots of storage space.



# Tager Carbo Plus

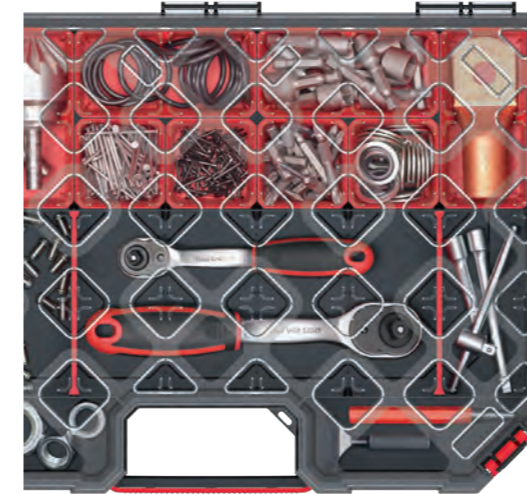

	TAGER CARBO PLUS organiser	TAGER CARBO PLUS organiser	TAGER CARBO PLUS organiser
	KTGC302510BS	KTGC403010BS	KTGC604010BS
colour	<span style="border: 1px solid black; padding: 1px;">CG6U</span>	<span style="border: 1px solid black; padding: 1px;">CG6U</span>	<span style="border: 1px solid black; padding: 1px;">CG6U</span>
mm	284 x 243 x 105	390 x 284 x 105	577 x 390 x 105
kg	-	-	-
pcs	5 /-	5 /-	5 /-
pcs	180	120	60
mm	~ 1680	~ 1700	~ 1770
	polycarbonate lid, mix of separators and boxes, two-component handle	polycarbonate lid, mix of separators and boxes, two-component handle	polycarbonate lid, mix of separators and boxes, two-component handle

**TAGER:**

- Body made of a mixture of increased strength polymers
- Ergonomic handle
- Transparent polycarbonate lid
- Functional bins and partitions
- Durable fasteners
- Lots of storage space



# Tager Carbo Plus organiser

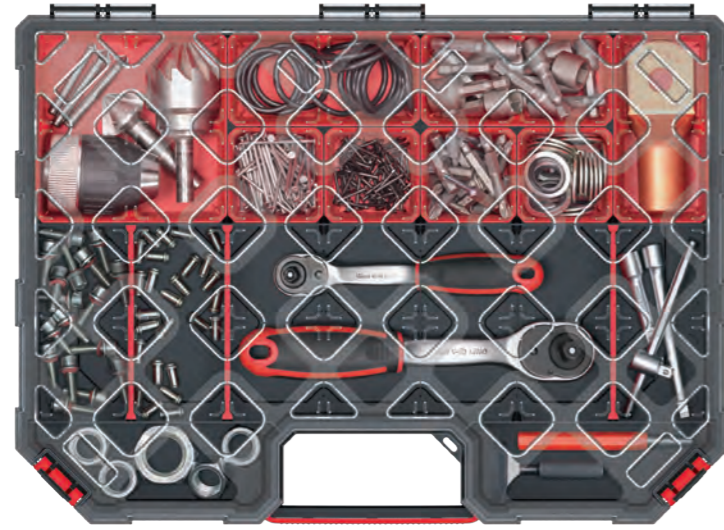

POLYCARBONATE LID

# Tager organiser

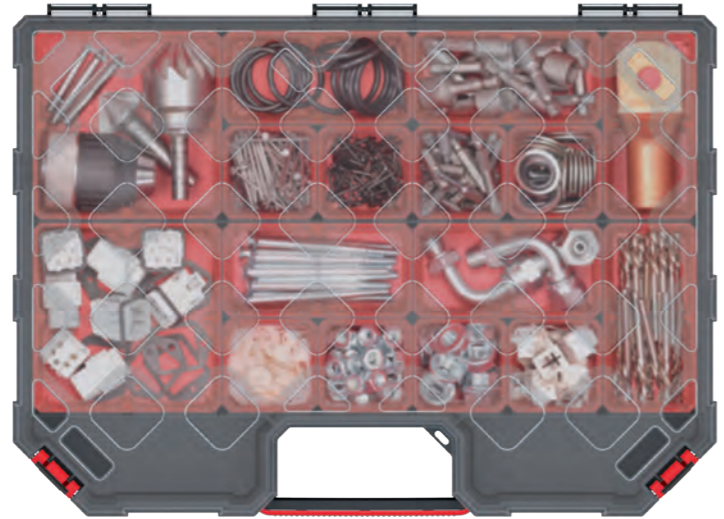

POLYPROPYLENE LID

# Tager organiser

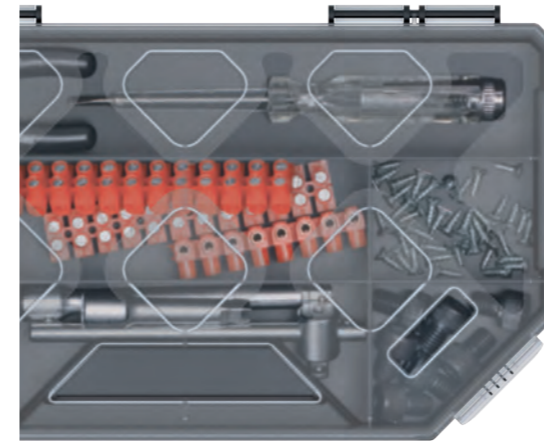

**TAGER:**

- Body made of a mixture of increased strength polymers
- Ergonomic handle
- Transparent lid
- Durable fasteners



	TAGER organiser	TAGER organiser	TAGER organiser	TAGER organiser
	KTG20154	KTG25154	KTG30204	KTG30254
colour	S429	S429	S429	S429
mm	195 x 142 x 40	243 x 142 x 40	284 x 195 x 40	284 x 243 x 40
kg	-	-	-	-
pcs	10 / 80	10 / 60	10 / 40	10 / 20
pcs	1440	960	480	480
mm	~ 1920	~ 1900	~ 1700	~ 1900
	polypropylene lid	polypropylene lid	polypropylene lid	polypropylene lid

# Tager organiser



	TAGER organiser	TAGER organiser	TAGER organiser	TAGER organiser
	KTG30206S	KTG30256S	KTG40306S	KTG60406S
colour	S429	S429	S429	S429
mm	284 x 195 x 60	284x243x60	390x284x60	577x390x60
kg	-	-	-	-
pcs	10 /-	10 /-	5 /-	5 /-
pcs	480	360	240	120
mm	~ 1880	~ 1900	~ 1920	~ 1850
i	polypropylene lid, separators, two-component handle	polypropylene lid, separators, two-component handle	polypropylene lid, separators, two-component handle	polypropylene lid, separators, two-component handle

**TAGER:**

- Body made of a mixture of increased strength polymers
- Ergonomic handle
- Transparent lid
- Functional partitions
- Durable fasteners



# Tager organiser

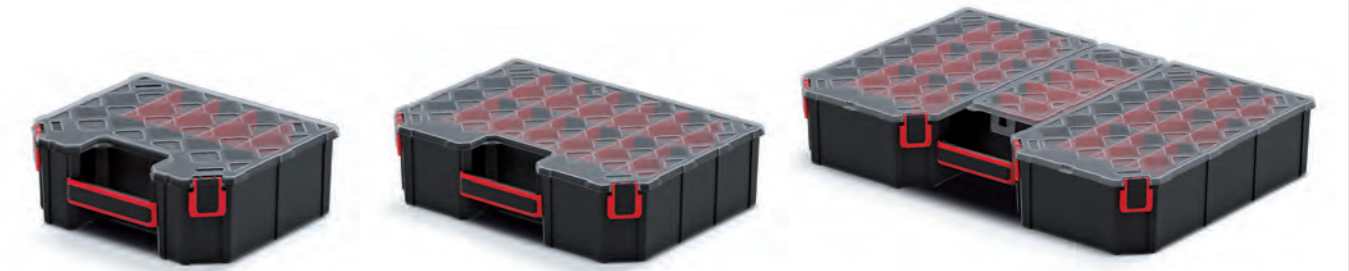
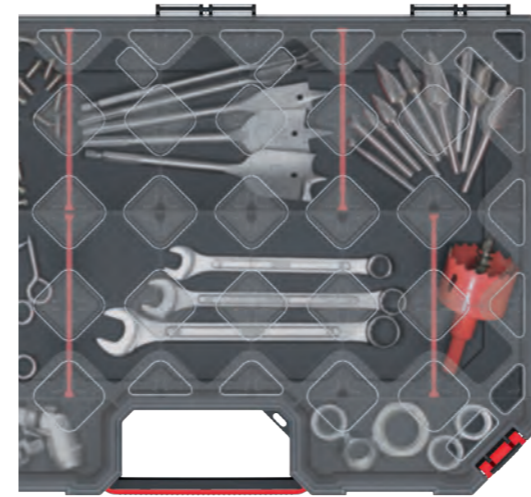

	TAGER organiser	TAGER organiser	TAGER organiser
	KTG302510S	KTG403010S	KTG604010S
colour	S429	S429	S429
mm	284 x 243 x 105	390 x 284 x 105	577 x 390 x 105
kg	-	-	-
pcs	5 /-	5 /-	5 /-
pcs	180	120	60
mm	~ 1680	~ 1700	~ 1770
i	polypropylene lid, separators, two-component handle	polypropylene lid, separators, two-component handle	polypropylene lid, separators, two-component handle

**TAGER:**

- Body made of a mixture of increased strength polymers
- Ergonomic handle
- Transparent lid
- Functional partitions
- Durable fasteners



# Tager organiser



	TAGER organiser	TAGER organiser	TAGER organiser	TAGER organiser
	KTG30206B	KTG30256B	KTG40306B	KTG60406B
colour	S429	S429	S429	S429
mm	284 x 195 x 60	284x243x60	390x284x60	577x390x60
kg	-	-	-	-
pcs	10 /-	10 /-	5 /-	5 /-
pcs	480	360	240	120
mm	~ 1880	~ 1900	~ 1920	~ 1850
	polypropylene lid, boxes, two-component handle	polypropylene lid, boxes, two-component handle	polypropylene lid, boxes, two-component handle	polypropylene lid, boxes, two-component handle

**TAGER:**

- Body made of a mixture of increased strength polymers
- Ergonomic handle
- Transparent lid
- Functional bins
- Durable fasteners



# Tager organiser

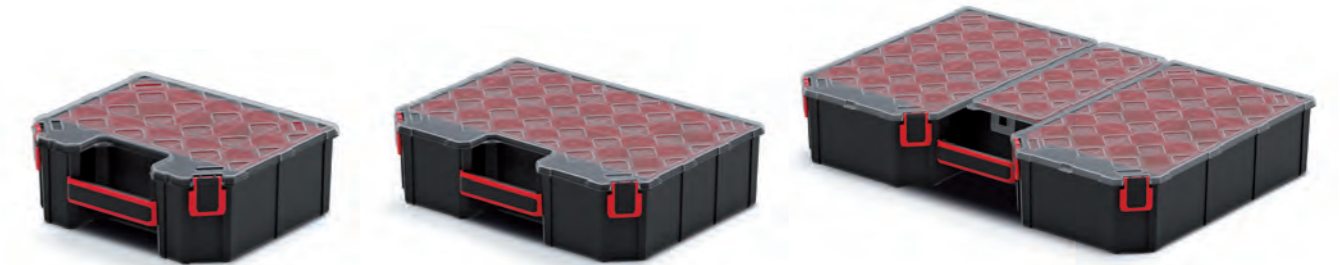
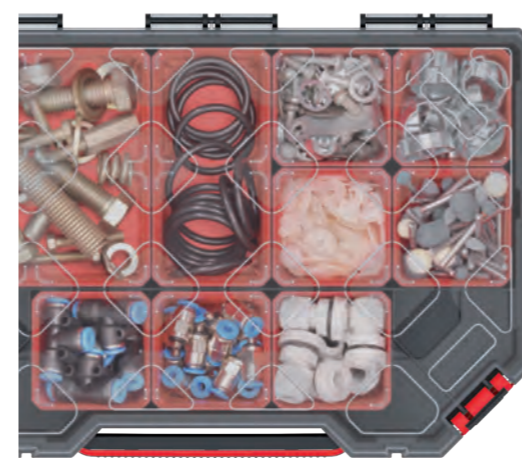

	TAGER organiser	TAGER organiser	TAGER organiser
	KTG302510B	KTG403010B	KTG604010B
colour	S429	S429	S429
mm	284 x 243 x 105	390 x 284 x 105	577 x 390 x 105
kg	-	-	-
pcs	5 /-	5 /-	5 /-
pcs	180	120	60
mm	~ 1680	~ 1700	~ 1770
	polypropylene lid, boxes, two-component handle	polypropylene lid, boxes, two-component handle	polypropylene lid, boxes, two-component handle

**TAGER:**

- Body made of a mixture of increased strength polymers
- Ergonomic handle
- Transparent lid
- Functional bins
- Durable fasteners



# Tager Case organiser



	TAGER CASE organiser set	TAGER CASE organiser set	TAGER CASE organiser set	TAGER CASE organiser set
	KTC40306B	KTC40306S	KTC30256B	KTC30256S
colour	S411	S411	S411	S411
mm	415 x 290 x 295	415 x 290 x 295	415 x 290 x 295	415 x 290 x 295
kg	-	-	-	-
pcs	-	-	-	-
pcs	40	40	40	40
mm	~ 1850	~ 1850	~ 1850	~ 1850
	3 x organisers with boxes, wall mountable, stackable, ergonomic handle, portable	3 x organisers with separators, wall mountable, stackable, ergonomic handle, portable	5 x organisers with boxes, wall mountable, stackable, ergonomic handle, portable	5 x organisers with separators, wall mountable, stackable, ergonomic handle, portable

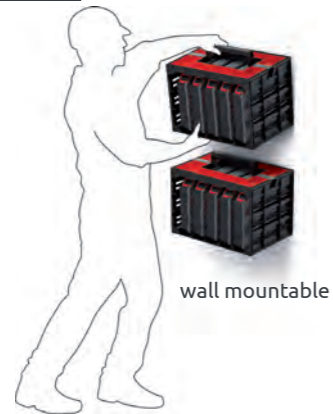
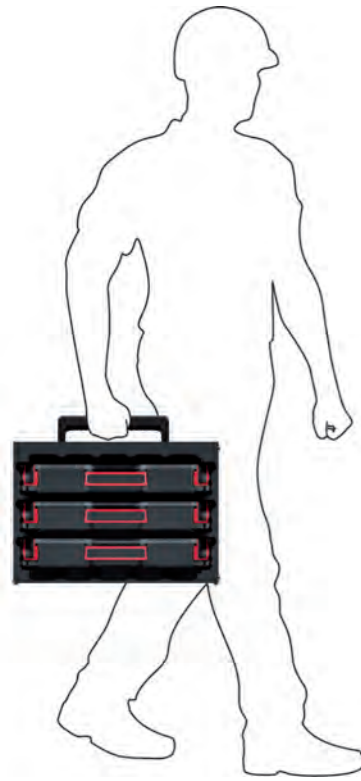

# Multicase Cargo organiser

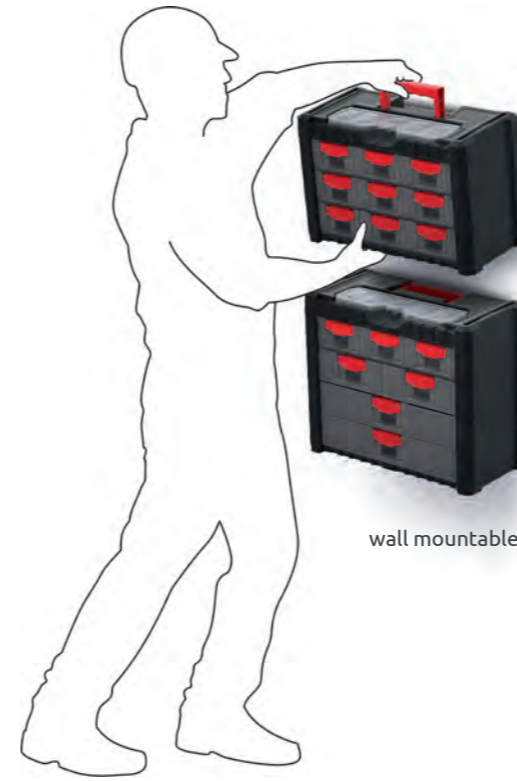

	MULTICASE CARGO organiser	MULTICASE CARGO organiser	MULTICASE CARGO organiser	MULTICASE CARGO organiser
	KMC301	KMC303	KMC401	KMC501
colour	S411	S411	S411	S411
mm	400 x 200 x 260	400 x 200 x 260	400 x 200 x 326	400 x 200 x 392
kg	-	-	-	-
pcs	-	-	-	-
pcs	81	81	60	54
mm	~ 1910	~ 1910	~ 1780	~ 1920
	wall mountable & stackable, transparent drawers, comfortable handle	wall mountable & stackable, transparent drawers, comfortable handle	wall mountable & stackable, transparent drawers, comfortable handle	wall mountable & stackable, transparent drawers, comfortable handle



# Nor organiser



	NOR organiser	NOR organiser	NOR organiser	NOR organiser
	KNO20154	KNO30204	KNO40307	KNO50407
colour	<span>S429</span>	<span>S429</span>	<span>S429</span>	<span>S429</span>
mm	195 x 155 x 35	290 x 195 x 35	390 x 290 x 65	490 x 390 x 65
kg	-	-	-	-
pcs	- / 48	15 / 60	10 / -	6 / -
pcs	1152	720	200	108
mm	~ 1800	~ 1700	~ 1800	~ 1650
	organisers for small parts, removable separators, transparent lid	organisers for small parts, removable separators, transparent lid	organisers for small parts, removable separators, transparent lid	organisers for small parts, removable separators, transparent lid

**NOR:**

- Designed to store and organise a large number of small items in one place
- Available in 4 sizes
- Removable separators which help to personalise the storage space
- Transparent lids made of impact-resistant polymer blend



# Nor Duo organiser



	NOR organiser set	NOR organiser set
	KNOS403015	KNOS504015
colour	<span>S429</span>	<span>S429</span>
mm	390 x 290 x 130	490 x 390 x 130
kg	-	-
pcs	5 / -	3 / -
pcs	100	54
mm	~ 1800	~ 1650
	double organisers for small parts, removable separators, transparent lid	double organisers for small parts, removable separators, transparent lid

**NOR DUO:**











- Designed to store and double organise a large number of small items in one place
- Available in 2 sizes
- Removable separators which help to personalise the storage space
- Transparent lids made of impact-resistant polymer blend





# Nors organiser



	NORS organiser	NORS organiser	NORS organiser
	KNO30205S	KNO35255S	KNO40305S
colour			
 mm	287 x 186 x 50	344 x 249 x 50	399 x 303 x 50
 kg	-	-	-
 pcs	10 / 40	10 / -	10 / -
 pcs	480	340	240
 mm	~ 1700	~ 1900	~ 1750
	organisers for small parts, removable separators, transparent lid	organisers for small parts, removable separators, transparent lid	organisers for small parts, removable separators, transparent lid









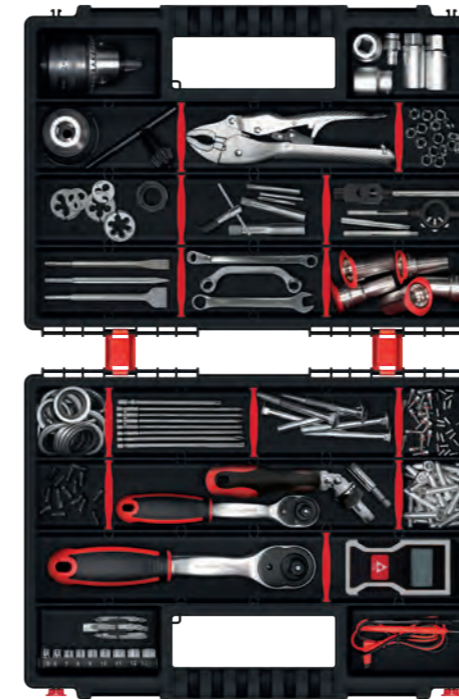

**NORS:**

- Designed to store and organise a large number of small items in one place
- Available in 3 sizes
- Removable separators which help to personalise the storage space
- Transparent lids made of impact-resistant polymer blend



# Nors Duo organiser



	NORS organiser set	NORS organiser set	NORS organiser set
	KNOS302010S	KNOS352510S	KNOS403010S
colour			
 mm	287 x 186 x 100	344 x 249 x 100	399 x 303 x 100
 kg	-	-	-
 pcs	5 / 20	5 / -	5 / -
 pcs	240	170	120
 mm	~ 1700	~ 1900	~ 1750
	double organisers for small parts, removable separators, transparent lid	double organisers for small parts, removable separators, transparent lid	double organisers for small parts, removable separators, transparent lid

**NORS DUO:**

- Designed to store and double organise a large number of small items in one place
- Available in 3 sizes
- Removable separators which help to personalise the storage space
- Transparent lids made of impact-resistant polymer blend



# Norb organiser



	NORB organiser	NORB organiser	NORB organiser
	KNO30205B	KNO35255B	KNO40305B
colour	S429	S429	S429
mm	287 x 186 x 50	344 x 249 x 50	399 x 303 x 50
kg	-	-	-
pcs	10 / 40	10 / -	10 / -
pcs	480	340	240
mm	~ 1700	~ 1900	~ 1750
	organisers for small parts, removable separators, transparent lid	organisers for small parts, removable separators, transparent lid	organisers for small parts, removable separators, transparent lid

**NORB:**

- Designed to store and organise a large number of small items in one place
- Available in 4 sizes,
- Removable separators which help to personalise the storage space
- Transparent lids made of impact-resistant polymer blend



# Norb Duo organiser



	NORB organiser set	NORB organiser set	NORB organiser set
	KNOS302010B	KNOS352510B	KNOS403010B
colour	S429	S429	S429
mm	287 x 186 x 100	344 x 249 x 100	399 x 303 x 100
kg	-	-	-
pcs	5 / 20	5 / -	5 / -
pcs	240	170	120
mm	~ 1700	~ 1900	~ 1750
	double organisers for small parts, removable separators, transparent lid	double organisers for small parts, removable separators, transparent lid	double organisers for small parts, removable separators, transparent lid

**NORB DUO:**

- Designed to store and double organise a large number of small items in one place
- Available in 2 sizes
- Removable separators which help to personalise the storage space
- Transparent lids made of impact-resistant polymer blend





You craft, we store.

## MSX Box organiser



You craft, we store.



	MSX box	MSX box	MSX box
	KMXB3015	KMXB3015S	KMXBB3015S
colour	S429	S429	S411
mm	285 x 158 x 57	285 x 158 x 57	285 x 158 x 57
kg	-	-	-
pcs	- / 32	- / 32	- / 32
pcs	576	576	576
mm	~ 1920	~ 1920	~ 1920
	organisers for small parts, transparent lid	organisers for small parts, 3 x separators, transparent lid	organisers for small parts, 3 x separators, black lid



# Nort & Knox organiser



	KNOX organiser	KNOX organiser	NORT organiser	NORT organiser	NORT organiser	NORT organiser
	KKNO2010	KKNO2015	KNO20154T	KNO30204T	KNO35255T	KNO40307T
colour	S429	S429	S429	S429	S429	S429
mm	180 x 90 x 35	200 x 160 x 35	195 x 155 x 35	290 x 195 x 35	344 x 249 x 50	390 x 290 x 65
kg	-	-	-	-	-	-
pcs	-/120	-/60	-/48	15/60	10/-	10/-
pcs	2160	1080	1152	720	340	200
mm	~ 1700	~ 1700	~ 1800	~ 1700	~ 1900	~ 1800
	transparent organisers for small parts, fixed separators	transparent organisers for small parts, fixed separators	organisers for small parts, removable separators, transparent	organisers for small parts, removable separators, transparent	organisers for small parts, removable separators, transparent	organisers for small parts, removable separators, transparent

**NORT:**

- Designed to store and organise a large number of small items in one place
- Available in 4 sizes,
- Removable separators which help to personalise the storage space
- Transparent organisers



# Nun organiser



	NUN organiser	NUN organiser	NUN organiser	NUN organiser	NUN organiser
	KNU20	KNU25	KNU30	KNU36	KNU40
colour	S429	S429	S429	S429	S429
mm	198 x 117 x 45	245 x 150 x 85	295 x 195 x 85	359 x 238 x 85	400 x 298 x 85
kg	-	-	-	-	-
pcs	-/45	-/38	-/24	-/16	-/12
pcs	1080	456	288	160	144
mm	~ 1900	~ 1700	~ 1700	~ 1770	~ 1830
	transparent organiser, fixed separators, hanging loop	transparent organiser, fixed separators, comfortable handle	transparent organiser, fixed separators, comfortable handle	transparent organiser, removable separators, comfortable handle	transparent organiser, removable separators, comfortable handle



# Battery Box organiser

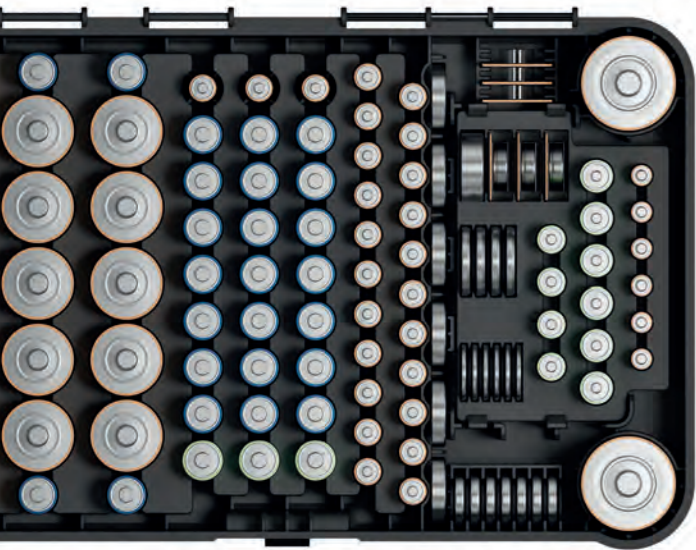







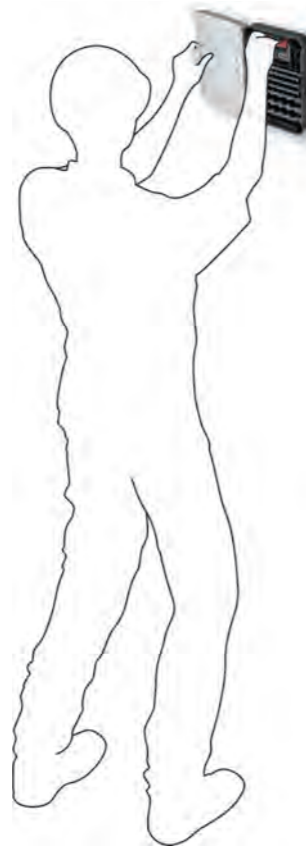

**BATTERY BOX:**

- Slots for battery storing
- Optional with battery tester or additional slots for tiny batteries
- Body made of a mixture of increased strength polymers
- Transparent polycarbonate lid
- Wall mountable

wall mountable









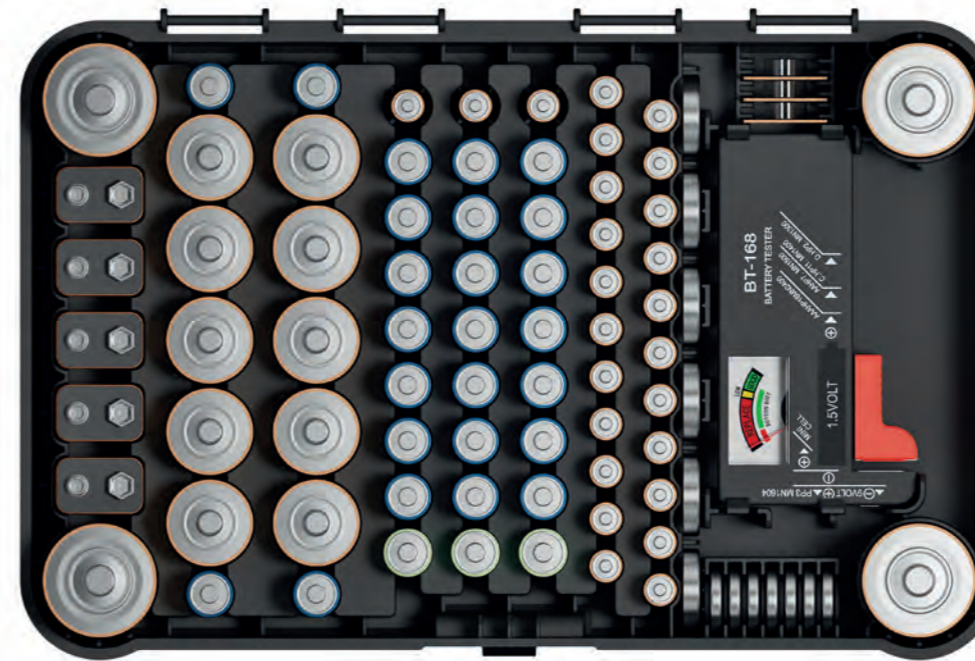

BATTERY BOX organiser	
	KBB03
 colour	<span style="border: 1px solid black; padding: 1px;">CG6U</span>
 mm	295 x 195 x 70
 kg	-
 pcs	8 / 32
 pcs	384
 mm	~ 1830
	polycarbonate cover, 115 slots for batteries



# Battery Box with tester organiser



BATTERY BOX WITH TESTER organiser	
	KBBT
 colour	<span style="border: 1px solid black; padding: 1px;">CG6U</span>
 mm	295 x 195 x 70
 kg	-
 pcs	8 / 32
 pcs	384
 mm	~ 1830
	polycarbonate cover, 85 slots for batteries, battery tester inside



# Truck Max storage bin



	TRUCK MAX storage bin	TRUCK MAX storage bin	TRUCK MAX storage bin
	KTRM4030	KTRM4040	KTRM6040
colour	S411	S411	S411
mm	396 x 290 x 280	396 x 380 x 282	580 x 380 x 342
kg	-	-	-
pcs	5 /-	5 /-	3 /-
pcs	160	120	81
mm	~ 1700	~ 1660	~ 1860

**TRUCK MAX:**

- Durable polymer blend body
- Stackable
- Wall mountable
- Handles for easy carrying



# Truck Max Plus storage bin

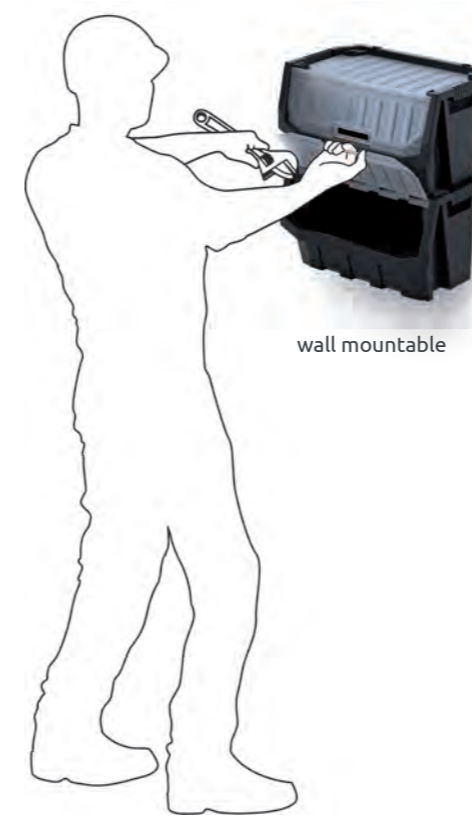

	TRUCK MAX PLUS storage bin	TRUCK MAX PLUS storage bin	TRUCK MAX PLUS storage bin
	KTRM4030F	KTRM4040F	KTRM6040F
colour	S411	S411	S411
mm	396 x 290 x 280	396 x 380 x 282	580 x 380 x 342
kg	-	-	-
pcs	- / 5	- / 5	- / 5
pcs	90	90	60
mm	~ 1700	~ 1700	~ 1920

**TRUCK MAX:**

- Durable polymer blend body
- Protective transparent cover
- Stackable
- Can be wall mountable
- Handles for easy carrying



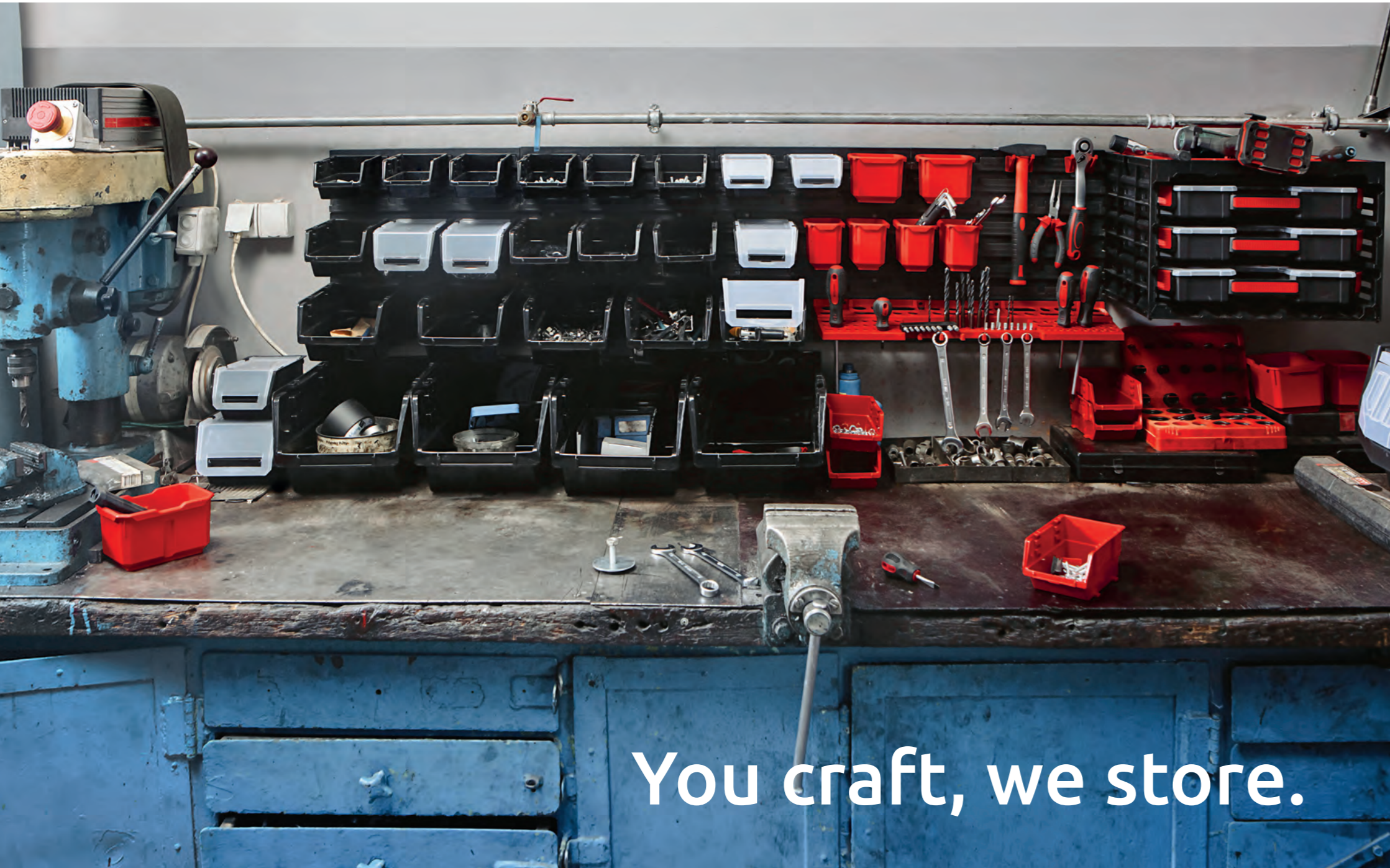

You craft, we store.

You craft, we store.

# Click Box storage bin



CLICK BOX storage bin

	KCB16	KCB23	KCB30	KCB36	KCB45
colour	S411	S411	S411	S411	S411
mm	162 x 108 x 75	225 x 140 x 95	300 x 200 x 140	360 x 240 x 160	450 x 300 x 190
kg	-	-	-	-	-
pcs	6 / 72	6 / -	6 / -	6 / -	4 / -
pcs	1296	504	192	90	56
mm	~ 1700	~ 1770	~ 1770	~ 1700	~ 1930

- CLIK BOX:**
- HI-TECH material POLYSTYRENE
  - Durable body
  - High load resistance
  - Interconnectable
  - Stackable
  - Flat inside
  - Possibility of building sets

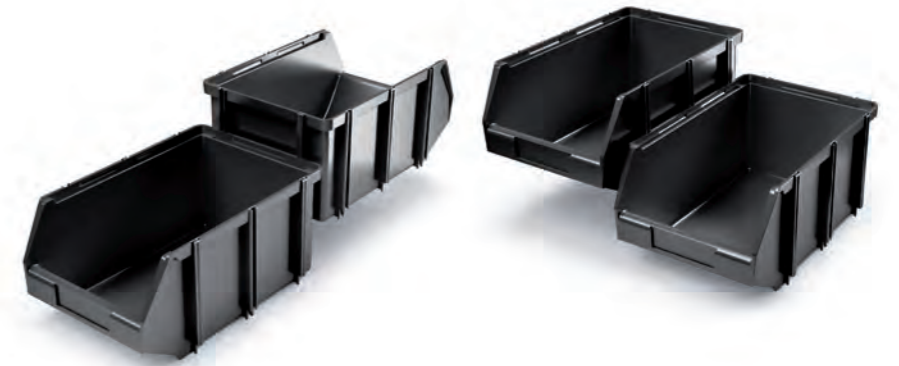

# Exe storage bin



EXE storage bin		KEX12	KEX16	KEX20	KEX24	KEX30	KEX40
colour		S411	S411	S411	S411	S411	S411
mm		119 x 77 x 58	156 x 99 x 74	198 x 118 x 94	237 x 159 x 118	296 x 197 x 147	393 x 283 x 192
kg		-	-	-	-	-	-
pcs		13 / 299	14 / 196	12 / 108	12 / -	5 / -	5 / -
pcs		4784	2352	1080	600	320	150
mm		~ 1900	~ 1950	~ 1850	~ 1750	~ 1900	~ 1900

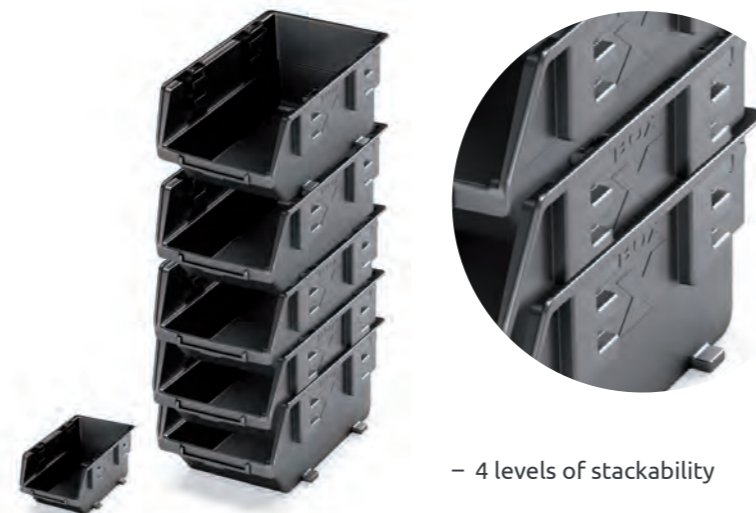

- 4 levels of stackability

**EXE:**

- Durable polymer blend body
- Interconnectable
- Can be wall-mounted with a dedicated hanging bar or panel
- 4 levels of stackability

# Exe Plus storage bin

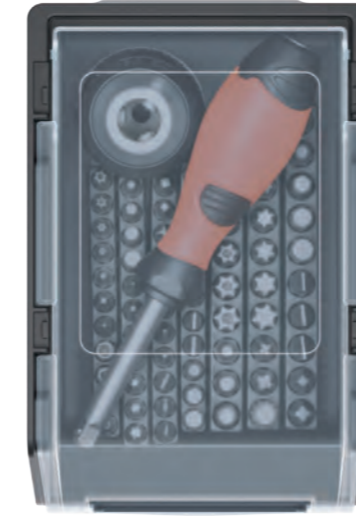

EXE PLUS storage bin		KEX12F	KEX16F	KEX20F	KEX24F	KEX30F	KEX40F
colour		S411	S411	S411	S411	S411	S411
mm		119 x 77 x 58	156 x 99 x 74	198 x 118 x 94	237 x 159 x 118	296 x 197 x 147	393 x 283 x 192
kg		-	-	-	-	-	-
pcs		8 / 184	8 / 112	6 / 54	5 / -	4 / -	3 / -
pcs		2208	1344	648	350	192	90
mm		~ 1860	~ 1700	~ 1860	~ 1800	~ 1850	~ 1850



**EXE PLUS:**

- Durable polymer blend body
- Transparent cover
- Stackable
- Interconnectable
- Can be wall-mounted with a dedicated hanging bar or panel



# Truck storage bin

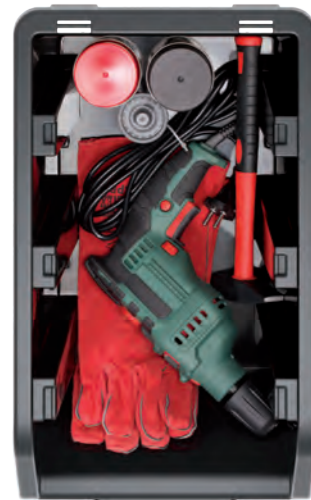

TRUCK storage bin

	KTR12	KTR16	KTR20	KTR23	KTR30	KTR40	KTR50
colour	S411 3020	S411 3020	S411 3020	S411 3020	S411 3020	S411 2030	S411 2030
mm	115 x 80 x 60	155 x 100 x 70	195 x 120 x 90	230 x 160 x 120	290 x 200 x 150	390 x 240 x 180	490 x 298 x 210
kg	-	-	-	-	-	-	-
pcs	36 / 900	33 / 462	28 / 252	16 / 128	15 / -	10 / -	6 / -
pcs	10800	5544	3024	1536	1080	560	216
mm	~ 1950	~ 1950	~ 1950	~ 1830	~ 1950	~ 1950	~ 1650

**TRUCK:**

- Body made of a durable polymer blend
- Can be wall mountable with a dedicated hanging bar or panel
- Stackable

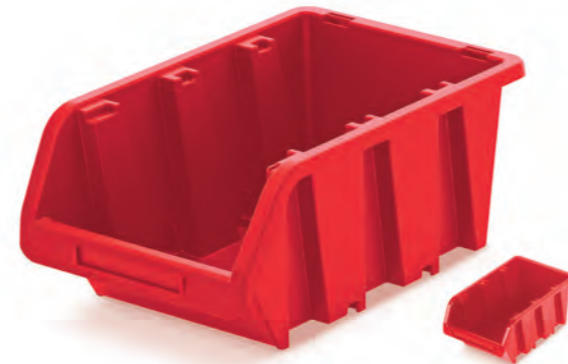

# Truck Plus storage bin

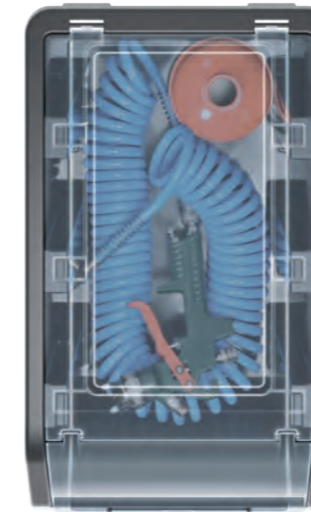

TRUCK PLUS storage bin

	KTR16F	KTR20F	KTR23F	KTR50F
colour	S411 3020	S411 3020	S411 3020	S411 3020
mm	155 x 100 x 70	195 x 120 x 90	230 x 160 x 120	490 x 298 x 210
kg	-	-	-	-
pcs	10 / 40	10 / 40	10 / 40	-
pcs	2400	1600	800	51
mm	~ 1770	~ 1930	~ 1770	~ 1830

**TRUCK PLUS:**

- Body made of a durable polymer blend
- Can be wall mountable with a dedicated hanging bar or panel
- Stackable
- Transparent lockable lid



## Bineer Short storage bin



### BINEER SHORT:

- Body made of a durable polymer blend
- Can be wall mountable with a dedicated hanging bar or panel
- Stackable



BINEER SHORT storage bin

	KBIS10	KBIS12	KBIS15	KBIS20	KBIS22	KBIS28
colour	3020 5411	3020 5411	3020 5411	3020 5411	3020 5411	3020 5411
mm	92 x 77 x 60	118 x 98 x 70	144 x 118 x 84	187 x 158 x 114	214 x 198 x 133	272 x 238 x 160
kg	-	-	-	-	-	-
pcs	28 / 728	24 / 384	16 / 288	14 / 126	14 / -	12 / -
pcs	13104	6912	3456	1512	1260	672
mm	~ 1700	~ 1700	~ 1830	~ 1700	~ 1930	~ 1810
i	economic packaging, stackable, moulded in card holder, hooks for hanging, edge design to allow vertical stacking					

## Bineer Short set storage bin



### BINEER SHORT SET:

- Body made of a durable polymer blend
- Can be wall-mounted with a dedicated hanging bar or panel
- Stackable



BINEER SHORT SET storage bin

	KBISS10	KBISS12	KBISS15	KBISS20	KBISS22	KBISS28
colour	3020 5411	3020 5411	3020 5411	3020 5411	3020 5411	3020 5411
mm	234 x 77 x 92	180 x 98 x 118	206 x 118 x 144	288 x 158 x 187	214 x 198 x 238	272 x 238 x 236
kg	-	-	-	-	-	-
pcs	- / 32	- / 24	- / 14	- / 12	5 / -	6 / -
pcs	768	576	336	144	225	168
mm	~ 1900	~ 1900	~ 1900	~ 1950	~ 1910	~ 1810
i	economic packaging, stackable, moulded in card holder, connector for bin joining sizes 10 - 12 -15, hooks for hanging, edge design to allow vertical stacking					



## Bineer Long storage bin



		BINEER LONG storage bin				
		KBIL12	KBIL16	KBIL20	KBIL25	KBIL30
colour		3020 5411	3020 5411	3020 5411	3020 5411	3020 5411
mm	← ↗ ↘	120 x 77 x 60	160 x 98 x 70	198 x 118 x 84	249 x 158 x 114	295 x 198 x 133
kg	⚖	-	-	-	-	-
pcs	📦 / 📦	24 / 480	24 / 288	16 / 224	12 / 84	14 / -
pcs	📦	8640	5184	2688	1008	1008
mm	📏	~ 1700	~ 1700	~ 1830	~ 1700	~ 1930
i		long storage bins, economic packaging, stackable, moulded in card holder, hooks for hanging, edge design to allow vertical stacking				

### BINEER LONG:

- Body made of a durable polymer blend
- Can be wall mountable with a dedicated hanging bar or panel
- Stackable

## Bineer Long set storage bin



		BINEER LONG SET storage bin				
		KBILS12	KBILS16	KBILS20	KBILS25	KBILS30
colour		3020 5411	3020 5411	3020 5411	3020 5411	3020 5411
mm	← ↗ ↘	190 x 77 x 120	160 x 98 x 160	198 x 118 x 155	249 x 158 x 213	295 x 198 x 195
kg	⚖	-	-	-	-	-
pcs	📦 / 📦	- / 28	- / 24	- / 16	- / 12	7 / -
pcs	📦	672	432	288	144	252
mm	📏	~ 1900	~ 1700	~ 1700	~ 1950	~ 1910
i		economic packaging, stackable, moulded in card holder, connector for bin joining sizes 12 - 16 - 20, hooks for hanging, edge design to allow vertical stacking				

### BINEER LONG SET:

- Body made of a durable polymer blend
- Can be wall mountable with a dedicated hanging bar or panel
- Stackable



## Titan Box set



TITAN BOX SET storage bin

	KTIS11	KTIS16
colour	3020 5411 mix 6 pcs	3020 5411 mix 4 pcs
mm	110 x 75 x 263	156 x 110 x 195
kg	-	-
pcs	- / 36	- / 24
pcs	648	432
mm	~ 1760	~ 1950
i	adjusted to hang at the toolboard	

## X Block Box set



X BLOCK BOX SET storage bin

	KXBS148	KXBS1614
colour	3020 5411 mix 6 pcs	3020 5411 mix 4 pcs
mm	140 x 75 x 280	157 x 140 x 210
kg	-	-
pcs	- / 24	- / 16
pcs	432	288
mm	~ 1830	~ 1830
i	adjusted to hang at the toolboard	

## Unite Box set



UNITE BOX SET storage bin

	KBS55	KBS115	KBS1111
colour	3020 5411 7 pcs	3020 5411 5 pcs	3020 5411 4 pcs
mm	55 x 55 x 165	110 x 55 x 132	110 x 110 x 112
kg	-	-	-
pcs	8 / 128	6 / 72	4 / 80
pcs	3072	1728	1280
mm	~ 1870	~ 1870	~ 1870
i	designed for heavy, optima, evo, smart, nor, standard packing 1 color per set		

### TITAN BOX:

- Made of resistant polymer blend
- A kit for arranging the workshop or storage space in any configuration
- Can be wall-mounted with a dedicated hanging bar or panel



### UNITE BOX SET:

- Made of resistant polymer blend
- A set of bins for storing small items
- Designed for Heavy, Optima, Evo, Smart, Nor

Product images are for illustrative purposes only and may differ from the actual product.



# Settruck

## set of storage bins



	KST16
colour	S411 3020 mix
	mm 580 x 235 x 130
	kg -
	pcs -
	pcs 78
	mm ~ 1850
	stackable storage bins, 16 Bins + 5 Hanging Bar

**SETTRUCK:**

- Made of resistant polymer blend
- A kit for arranging the workshop or storage space in any configuration



# Multiholder

## hanger



	KMH30	KMH60
colour	S411	S411
	mm 310 x 98 x 70	mm 597 x 128 x 118
	kg ~ 7	kg ~ 15
	pcs 5 / 40	pcs 4 / 20
	pcs 720	pcs 200
	mm ~ 1820	mm ~ 1770
	universal tool holder	universal tool holder

**MULTIHOLDER:**

- A holder for workshop or garden hand tools
- Made of polymer blends with increased strength
- A flexible insert guarantees that tools of various sizes are kept in place



Product images are for illustrative purposes only and may differ from the actual product.

# Orderline set

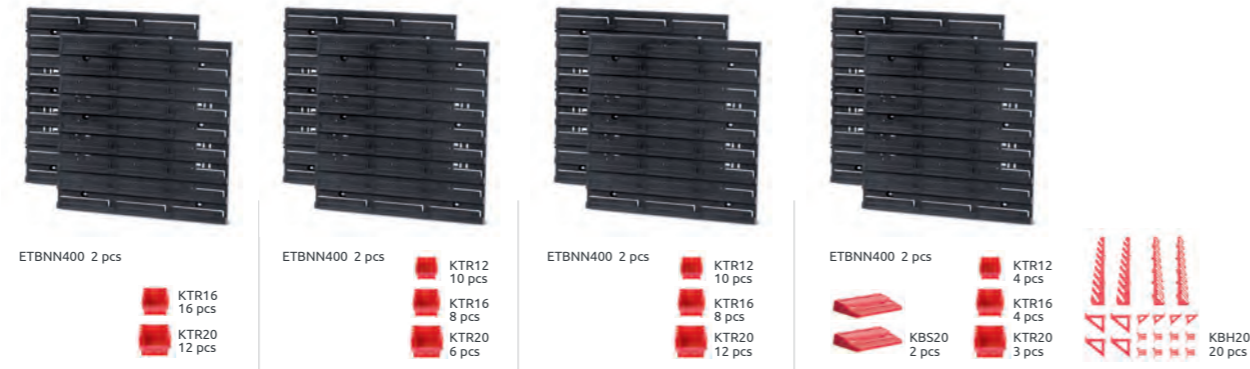

	KOR1	KOR2	KOR3	KOR4
colour	S411	S411	S411	S411
mm	400 x 165 x 400	400 x 165 x 400	400 x 165 x 400	400 x 165 x 400
kg	-	-	-	-
pcs	-/1	-/1	-/1	-/1
pcs	60	60	60	60
mm	~ 1800	~ 1800	~ 1800	~ 1800
i	2 x toolboard + bins	2 x toolboard + bins	2 x toolboard + bins	2 x toolboard + bins, tool hangers



- ORDRLINE:**
- The panel is made of durable polymer mix
  - Holes for mounting pins
  - Interconnectable
  - Compatible with Truck, Binner, Exe containers, X Block and Titan Bins

# Orderline set



	KOR5	KOR6
colour	S411	S411
mm	400 x 110 x 400	400 x 165 x 400
kg	-	-
pcs	-/1	-/1
pcs	90	60
mm	~ 1870	~ 1800
i	board + bins	2 x toolboard + Titan boxes



- ORDERLINE - panel with workshop containers:**
- Made of resistant polymer blend
  - A kit for arranging the workshop or storage space in any configuration

# Bineer Board



	HANGING BAR		BINEER BOARD set		BINEER BOARD set		BINEER BOARD	
	KHB40	50 pcs	KBBS4013	2 pcs	KBBS4040	2 pcs	KBB6040	1 pc
colour	S411		S411		S411		S411	
	mm	386 x 8 x 43	386 x 18 x 130	386 x 18 x 390	576 x 18 x 390			
	kg	-	-	-	-			
	pcs	- / 50	- / 42	- / 13	- / 30			
	pcs	8500	756	234	360			
	mm	~ 1480	~ 1700	~ 1700	~ 1830			
		interconnectable hanging bar	interconnectable, tool board	interconnectable, tool board	interconnectable, tool board			



### BINEER BOARD:

- The panel is made of durable polymer mix
- Holes for mounting pins
- Interconnectable
- Compatible with Truck, Binner, Exe containers, X Block and Titan Bins

# Bineer accessories



	BINEER HOOKS set		BINEER HOOKS set		BINEER SHELVES set		BINEER SHELVES set		BINEER SHELF	
	KBH16	16 pcs	KBH20	20 pcs	KBS20	2 pcs	KBSS40	2 pcs	KBS60	1 pc
colour	3020		3020		3020		3020		3020	
	mm	130 x 130	200 x 320	190 x 111 x 55	384 x 111 x 50	580 x 158 x 67				
	kg	-	-	-	-	-				
	pcs	26 / 104	10 / 20	10 / 100	8 / -	8 / 32				
	pcs	2496	640	1200	576	384				
	mm	~1870	~ 1700	~ 1830	~ 1830	~ 1830				
		tool hangers	tool hangers	tool shelf	tool shelf	tool shelf				



### BINEER HOOKS:

- Made of resistant polymer blend
- Possibility of arranging the workshop tool panel in any configuration

### BINEER SHELVES:

- Made of resistant polymer blend
- A set for arranging the workshop tool panel in any configuration



# Titan Stand

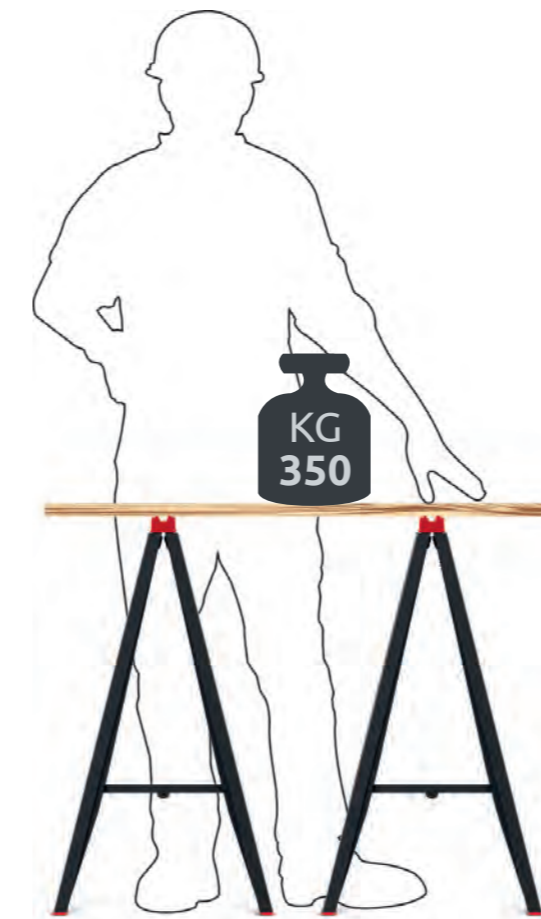

a pruning slot with a measure

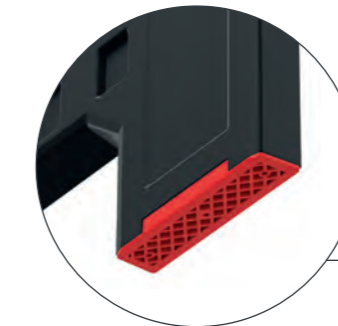

anti slip stopper



## TITAN STAND:

- Universal construction and workshop stands
- Very durable design
- Easy to store and unfold quickly
- Top edge with a handy ruler specially shaped to make easier cutting pipes and bars
- The stands provided with flexible anti-slip feet to prevent vibrations and movements during use
- Load carrying capacity of up to 350 kg per set of 2 pcs

	TITAN stand
	KTIS8060
<b>colour</b>	<b>S411</b>
	mm 580 x 415 x 770
	kg ~ 175
	pcs - / 6
	pcs 60
	mm ~ 1760





You craft, we store.



# Titan Ladder

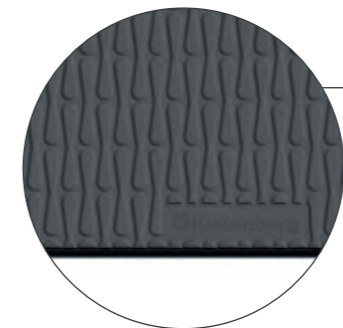

new

Two-Side access steps

anti slip stopper



### TITAN LADDER:

- Folding ladder
- Body made of reinforced structure
- EN-14183 : 2003 certificate
- Anti slip surface of steps and landing
- Anti slip stopper
- Pressure resistance up to 150 kg
- Steps on two sides

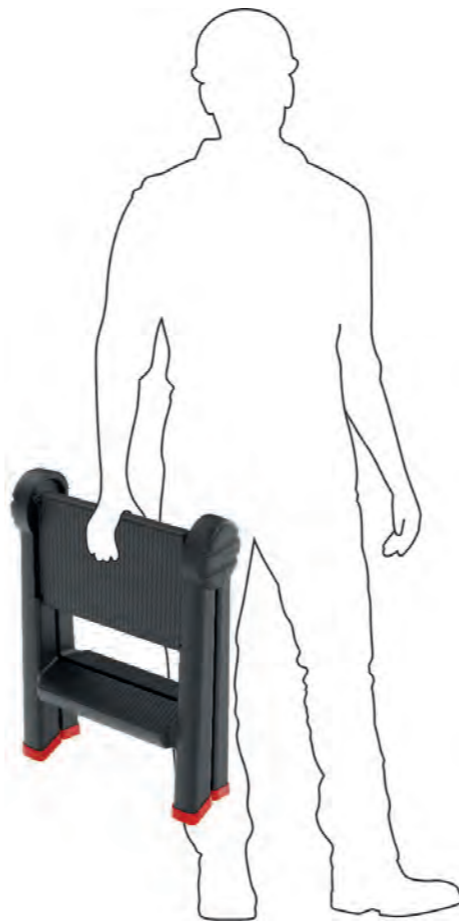

Two-Side access steps

TITAN ladder	
	KLD4565
	S411
	mm 470 x 435 x 630
	kg ~ 150
	pcs -
	pcs 30
	mm ~ 1930
	Two-Side Access Step Ladder - with steps on both sides for comfortable use
	min. -18°C max +40°C

# Bucket



BUCKET funnel

BUCKET round

	KBU12L	KBU16L	KBU20L	KBU05	KBU12	KBU16	KBU20
colour	S411	S411	S411	S411	S411	S411	S411
Ø ↑ mm	310 x 240	340 x 255	365 x 280	240 x 200	310 x 240	340 x 255	365 x 280
l	12	16	20	5	12	16	20
📦 / 📦 pcs	-	-	-	-	-	-	-
📦 pcs	1000	640	480	1200	1000	640	480
📏 mm	~ 1850	~ 1950	~ 1950	~ 1600	~ 1850	~ 1950	~ 1950
📄	metal handles bent inside, building bucket with a funnel, measure			metal handles bent inside, building bucket round, measure			

**BUCKET:**

- Metal handles
- Measure
- Building bucket round

# Container



CONTAINER round

CONTAINER rectangular

	KCOR45	KCOR65	KCOR90	KCON40	KCON60	KCON80	KCO60	KCO80
colour	S411	S411	S411	S411	S411	S411	S411	S411
Ø ↑ mm	500 x 330	580 x 350	630 x 420	-	-	-	-	-
← ↗ ↑ mm	-	-	-	720 x 410 x 220	720 x 410 x 285	780 x 480 x 300	710 x 410 x 280	780 x 470 x 300
l	45	65	90	40	60	80	60	80
📦 / 📦 pcs	-	-	-	-	-	-	-	-
📦 pcs	140	140	140	180	180	90	165	90
📏 mm	~ 1950	~ 1950	~ 1950	~ 1850	~ 1950	~ 1750	~ 1900	~ 1750
📄	round building container, measure			rectangular building container, measure			rectangular building container, measure	

**CONTAINER:**

- Building container



This catalogue does not constitute an offer for a legal contract. All content and promotional materials contained therein are for information purposes only.

Accessories and additional features presented in the catalogue may differ from the commercial offer.

The colour of the products are for marketing use only and may differ from the actual colors.

Tools shown in the pictures are not included.

All rights are reserved by Prosperplast 1 Spółka z o. o. and content may not be reproduced, downloaded, disseminated, published or transferred in any form or by any means, except with the prior written permission of Prosperplast 1 Spółka z o.o.

We are not responsible for printing mistakes.

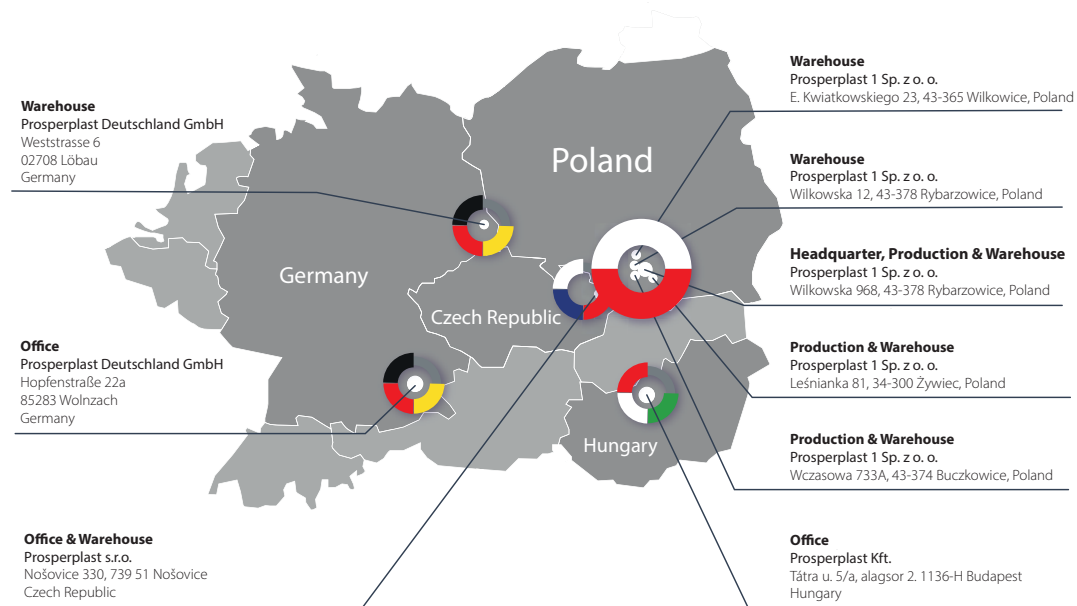

## Contact us



### Headquarter, Production & Warehouse

Prosperplast 1 Sp. z o. o.  
Wilkowska 968  
43-378 Rybarzowice  
Poland

tel. +48 33 817 70 03  
fax +48 33 817 60 81

biuro@prosperplast.pl  
office@prosperplast.pl  
www.prosperplast.pl



### Office

Prosperplast Deutschland GmbH  
Hopfenstraße 22a  
85283 Wolnzach  
Germany

tel. +49 8442 9628499  
tel. +49 8442 9588 30  
fax +49 8442 9680853

kontakt@prosperplast.de  
www.prosperplast.de



### Office & Warehouse

Prosperplast s.r.o.  
Nošovice 330  
739 51 Nošovice  
Czech Republic

tel. +420 553 034 443  
mob +420 730 894 721

info@prosperplast.cz  
www.prosperplast.cz



### Office

Prosperplast Kft.  
Tátra u. 5/a, alagsor 2.  
1136-H Budapest,  
Hungary

tel. +36 30 4095 120  
mob +36 30 4095 710

office@prosperplast.hu  
www.prosperplast.hu



Prosperplast 1 Sp. z o.o.  
Wilkowska 968  
43-378 Rybarzowice  
Poland

**[kistenberg.com](https://kistenberg.com)**

Feel free to place your order via B2B