

N Á V O D

OCHRANNÝ ŠTÍT TVÁŘE

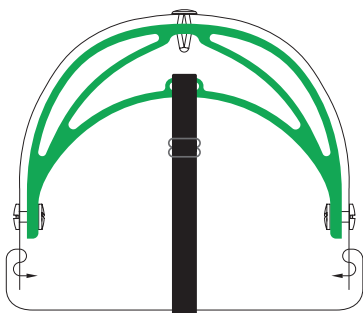

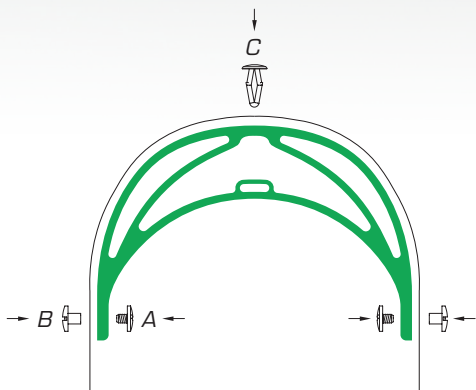

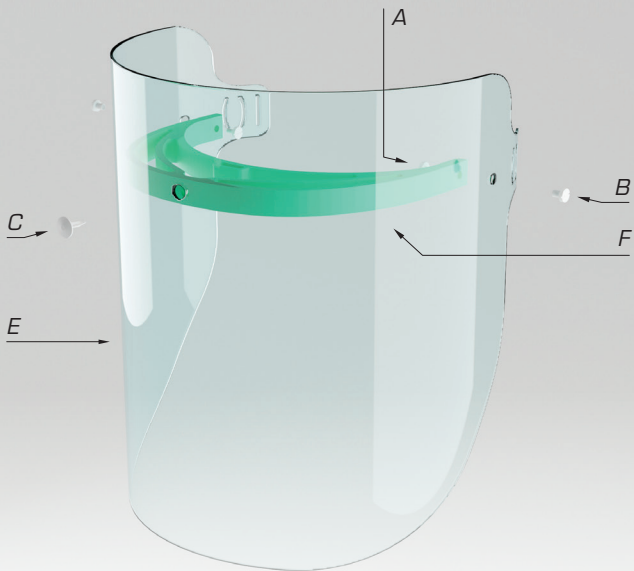
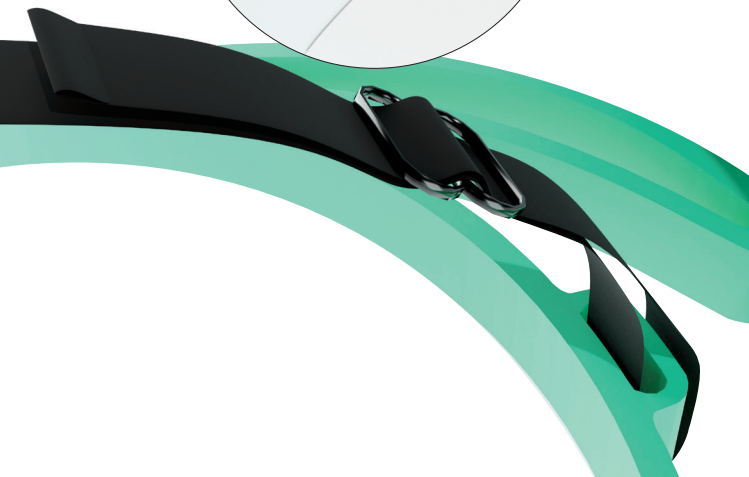
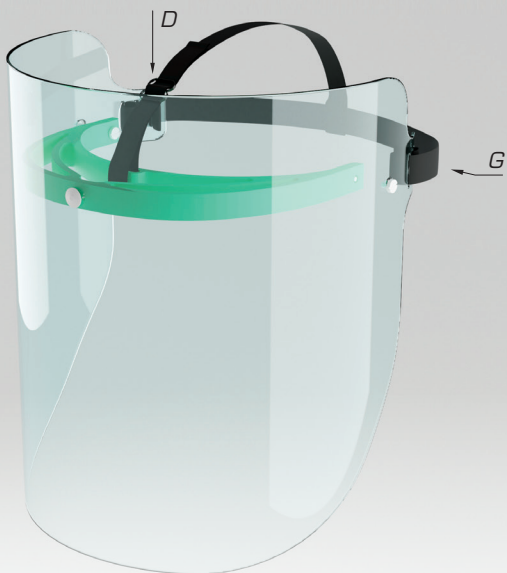

OCHRANNÝ ŠTÍT TVÁRE

OBSAH BALENIA

plastová skrutka a nit (materiál: HDPE)

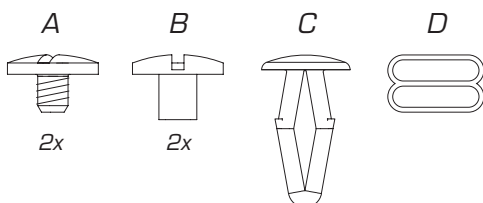

E | priehľadný štít (materiál: PETG 0,4 mm)

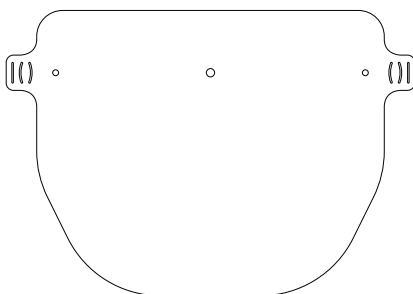

F | vysoko odolný nosič (materiál: PE300)

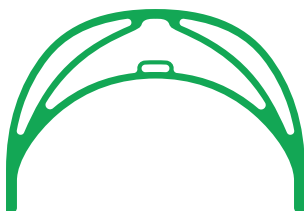

G | nastaviteľná plochá guma 15 mm a 20 mm

